

Grinding wheel adapter

and
Accessories



grinding deserves SOLUTIONS

GDS[®]
Made in Germany



CONTENT

Status Oct. 2023

ANCA	4-17
Deckel/ISO6	18-19
EWAG	20-23
Haas	24-28
Hawema	29-30
Reinecker	31-35
Rollomatic	36-44
Saacke	45-48
Schneeberger	49-55
Schütte	56-59
SMP	60-61
Strausak	62-67
TTB	68
Vollmer	69-70
Walter	71-78
Zaro	79-80
Adapters for dressing, presetting etc.	81-82
Adapter SK40 and SK50	83
Reduction adapters for gr. wheel adapters	84
Test and adjusting mandrels	85
Balancing technology	86-87
Accessories	88
GDS sale and service partners	89-92
Space for your notes	93-95

Grinding wheel adapter and accessories

Precision grinding requires an optimal spindle and a flawless grinding wheel, both of which depend on a perfect grinding wheel adapter.

"Our quality for your success"

We adapt to your requirements and guarantee our quality.

GDS - the precision makers



Competence and innovation

Our grinding wheel adapters are characterised by the following:



Maximum taper accuracy by using constantly controlled and calibrated measuring equipment.



Absolute accuracy of fit and optimum radial and axial run-out.



Extreme load-bearing capacity due to the use of tempered material and the best heat treating processes.



Optimum surface quality and associated long-term dimensional stability and precision, as well as spindle protection as a result of finished surfaces.



Balanced models for improved grinding results and spindle life.

ANCA
Deckel/ISO6
EWAG
Haas
Hawema
Reinecker
Rollomatic
Saacke
Schneeberger
Schütte
SMP
Strausak
TTB
Vollmer
Walter
Zaro
Adapter
Test mand.
Balanc. tech.

ANCA Internal taper 30 // Shaft $\phi 32$ mm // RS $\phi 50$ mm

For ANCA tool grinding machines with ring set $\phi 50$ mm
with integrated clamping and press-off system (M8 bolt)

GWA Internal taper 30 // $\phi 32$ mm // RS $\phi 50$ mm

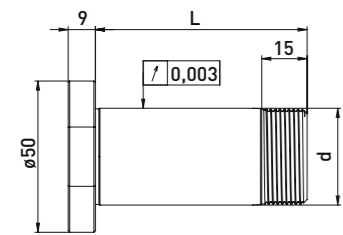
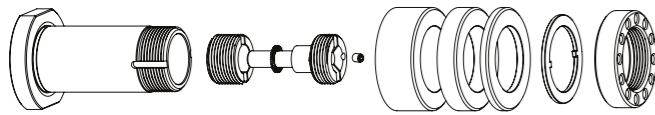

Delivered equipped:

Installation system, ring set $\phi 50$ mm, lock washer and clamping nut ANCA with balancing hole

Ring set $\phi 50$ mm

Order No.	Internal taper	d	L	B20	B10	B4
300020612	30	32	53	1	1	2
300020622	30	32	70	1	2	4
300020632	30	32	85	2	2	3
300020642	30	32	100	2	3	4

GWA Internal taper 30 // $\phi 32$ mm // without RS

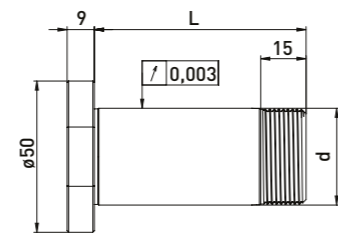
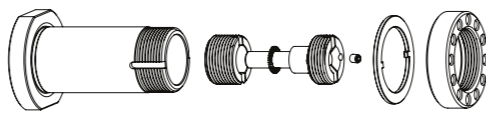

Delivered equipped:

Installation system, lock washer and clamping nut ANCA with balancing hole

Order No.	Internal taper	d	L
300020611	30	32	53
300020621	30	32	70
300020631	30	32	85
300020641	30	32	100

ANCA grinding wheel adapter Internal taper 30 // Shaft $\phi 32$ mm // Ring set $\phi 50$ mm

Order No.	Name
350050010	Universal assembly device $\phi 50$
350040030	Clamping nut wrench PC39 for ANCA nut
350020102	ANCA installation system with M8 screw
350060011	Assembly wrench set installation system ANCA (SW 6 + SW 2)
750000001	Clamping wrench SW 6,0 x 150
350020027	*Balancing weight pair for clamping nut $\phi 47$ // 70gmm

Order No.	Name
350011220	Spacer ring $\phi 50$ x $\phi 32$ x 20
350011210	Spacer ring $\phi 50$ x $\phi 32$ x 10
350011204	Spacer ring $\phi 50$ x $\phi 32$ x 4
350030040	Lock washer $\phi 43$ x $\phi 32$ x 2
350020050	Clamping nut ANCA balancing hole $\phi 47$ x 12 M31,5 x 1,5
350020026	*Clamping nut with balancing option $\phi 47$ x 12 M31,5 x 1,5

ANCA Internal taper 30 // Shaft $\phi 32$ mm // RS $\phi 50$ mm

For ANCA tool grinding machines with ring set $\phi 50$ mm
with integrated clamping and press-off system (M14 x 1.5 nut)

GWA Internal taper 30 // $\phi 32$ mm // RS $\phi 50$ mm

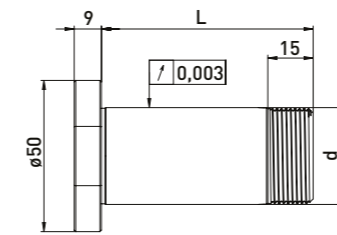
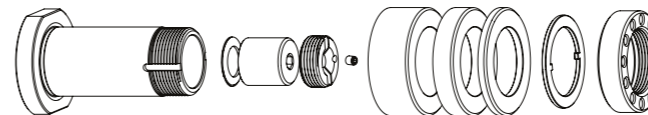

Delivered equipped:

Installation system, ring set $\phi 50$ mm, lock washer and clamping nut ANCA with balancing hole

Ring set $\phi 50$ mm

Order No.	Internal taper	d	L	B20	B10	B4
300020212	30	32	53	1	1	4
300020222	30	32	70	1	2	4
300020232	30	32	85	2	2	3
300020242	30	32	100	2	3	4

GWA Internal taper 30 // $\phi 32$ mm // without RS

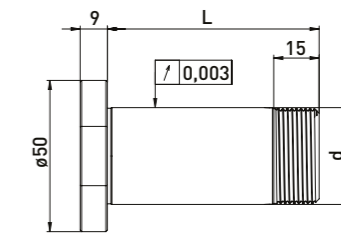
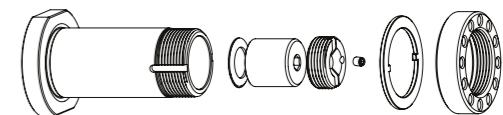

Delivered equipped:

Installation system, lock washer and clamping nut ANCA with balancing hole

Order No.	Internal taper	d	L
300020211	30	32	53
300020221	30	32	70
300020231	30	32	85
300020241	30	32	100

Accessories ANCA grinding wheel adapter Internal taper 30 // Shaft $\phi 32$ mm // Ring set $\phi 50$ mm

Order No.	Name
350050010	Universal assembly device $\phi 50$
350040030	Clamping nut wrench PC39 for ANCA nut
350020101	Installation system with M14 x 1.5 nut
350060011	Assembly wrench set installation system ANCA (SW 6 + SW 2)
750000001	Clamping wrench SW 6,0 x 150
350020027	*Balancing weight pair for clamping nut $\phi 47$ // 70gmm

Order No.	Name
350011220	Spacer ring $\phi 50$ x $\phi 32$ x 20
350011210	Spacer ring $\phi 50$ x $\phi 32$ x 10
350011204	Spacer ring $\phi 50$ x $\phi 32$ x 4
350030040	Lock washer $\phi 43$ x $\phi 32$ x 2
350020050	Clamping nut ANCA balancing hole $\phi 47$ x 12 M31,5 x 1,5
350020026	*Clamping nut with balancing option $\phi 47$ x 12 M31,5 x 1,5

ANCA Internal taper 30 // Shaft $\varnothing 31,75$ mm (1¼) // RS $\varnothing 50$ mm

For ANCA tool grinding machines with ring set $\varnothing 50$ mm
with integrated clamping and press-off system (M8 bolt)

GWA Internal taper 30 // $\varnothing 31,75$ mm (1¼) // RS $\varnothing 50$ mm

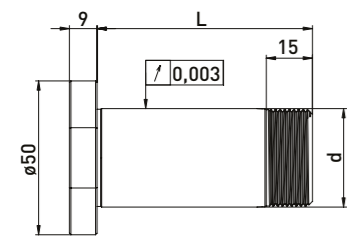
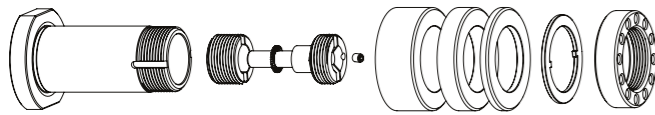

Delivered equipped:
Installation system, ring set $\varnothing 50$ mm, lock washer and clamping nut ANCA balancing hole

Order No.	Internal taper	d	L	Ring set $\varnothing 50$ mm		
				B20	B10	B4
300020512	30	31,75	53	1	1	2
300020522	30	31,75	70	1	2	4
300020532	30	31,75	85	2	2	3
300020542	30	31,75	100	2	3	4

GWA Internal taper 30 // $\varnothing 31,75$ mm // without RS

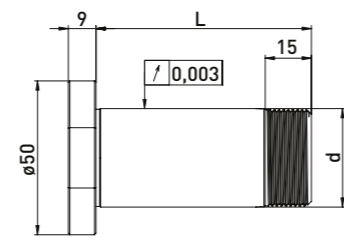
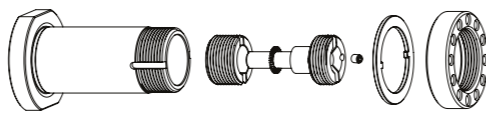

Delivered equipped:
Installation system, lock washer and clamping nut ANCA balancing hole

Order No.	Internal taper	d	L
300020511	30	31,75	53
300020521	30	31,75	70
300020531	30	31,75	85
300020541	30	31,75	100

Accessories ANCA grinding wheel adapter Internal taper 30 // Shaft $\varnothing 31,75$ mm (1¼) // Ring set $\varnothing 50$ mm

Order No.	Name	
350050010	Universal assembly device $\varnothing 50$	
350040030	Clamping nut wrench PC39 for ANCA nut	
350020102	ANCA installation system with M8 screw	
350060011	Assembly wrench set installation system ANCA (SW 6 + SW 2)	
750000001	Clamping wrench SW 6,0 x 150	
350020027	*Balancing weight pair for clamping nut $\varnothing 47$ // 70gmm	

Order No.	Name	
350011120	Spacer ring $\varnothing 50$ x $\varnothing 31,75$ x 20	
350011110	Spacer ring $\varnothing 50$ x $\varnothing 31,75$ x 10	
350011104	Spacer ring $\varnothing 50$ x $\varnothing 31,75$ x 4	
350030040	Lock washer $\varnothing 43$ x $\varnothing 32$ x 2	
350020050	Clamping nut ANCA balancing hole $\varnothing 47$ x 12 M31,5 x 1,5	
350020026	*Clamping nut with balancing option $\varnothing 47$ x 12 M31,5 x 1,5	

ANCA Internal taper 30 // Shaft $\varnothing 31,75$ mm (1¼) // RS $\varnothing 50$ mm

For ANCA tool grinding machines with ring set $\varnothing 50$ mm
with integrated clamping and press-off system (M14 x 1.5 nut)

GWA Internal taper 30 // $\varnothing 31,75$ mm (1¼) // RS $\varnothing 50$ mm

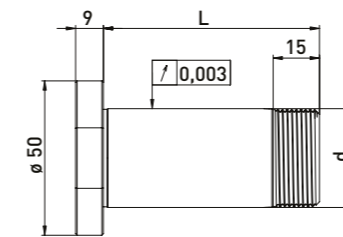
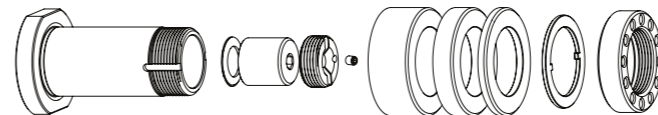

Delivered equipped:
Installation system, ring set $\varnothing 50$ mm, lock washer and clamping nut ANCA balancing hole

Order No.	Internal taper	d	L	Ring set $\varnothing 50$ mm		
				B20	B10	B4
300020112	30	31,75	53	1	1	2
300020122	30	31,75	70	1	2	4
300020132	30	31,75	85	2	2	3
300020142	30	31,75	100	2	3	4

GWA Internal taper 30 // $\varnothing 31,75$ mm // without RS

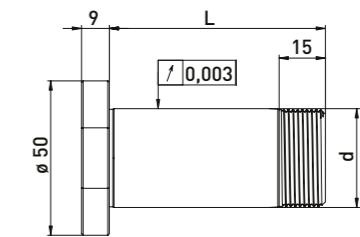
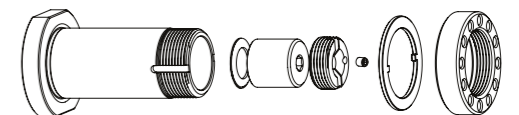

Delivered equipped:
Installation system, lock washer and clamping nut ANCA balancing hole

Order No.	Internal taper	d	L
300020111	30	31,75	53
300020121	30	31,75	70
300020131	30	31,75	85
300020141	30	31,75	100

Accessories ANCA grinding wheel adapter Internal taper 30 // Shaft $\varnothing 31,75$ mm (1¼) // Ring set $\varnothing 50$ mm

Order No.	Name	
350050010	Universal assembly device $\varnothing 50$	
350040030	Clamping nut wrench PC39 for ANCA nut	
350020101	Installation system with M14 x 1.5 nut	
350060011	Assembly wrench set installation system ANCA (SW 6 + SW 2)	
750000001	Clamping wrench SW 6,0 x 150	
350020027	*Balancing weight pair for clamping nut $\varnothing 47$ // 70gmm	

Order No.	Name	
350011120	Spacer ring $\varnothing 50$ x $\varnothing 31,75$ x 20	
350011110	Spacer ring $\varnothing 50$ x $\varnothing 31,75$ x 10	
350011104	Spacer ring $\varnothing 50$ x $\varnothing 31,75$ x 4	
350030040	Lock washer $\varnothing 43$ x $\varnothing 32$ x 2	
350020050	Clamping nut ANCA balancing hole $\varnothing 47$ x 12 M31,5 x 1,5	
350020026	*Clamping nut with balancing option $\varnothing 47$ x 12 M31,5 x 1,5	

For ANCA tool grinding machines with ring set $\varnothing 50$ mm
with integrated clamping and press-off system M6 clamping screw

For ANCA tool grinding machines with ring set $\varnothing 50$ mm
with integrated clamping and press-off system M6 clamping screw

GWA manual HSK-F40 // $\varnothing 20$ mm // RS $\varnothing 50$ mm

GWA manual HSK-F40 // $\varnothing 20$ mm // without RS

GWA manual HSK-F40 // $\varnothing 31,75$ mm (1¼) // RS $\varnothing 50$ mm

GWA manual HSK-F40 // $\varnothing 31,75$ mm // without RS

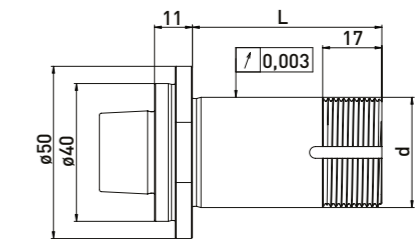
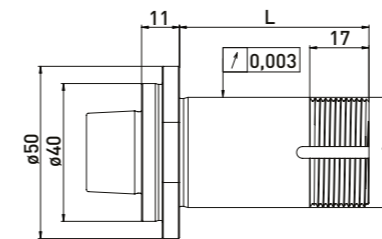
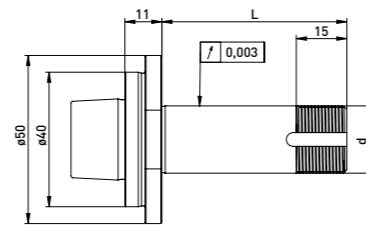
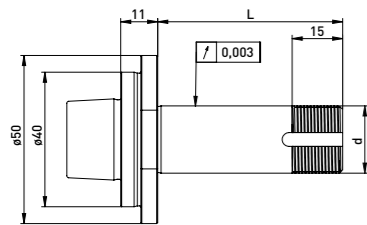
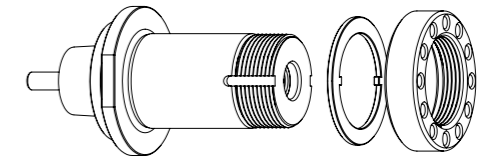
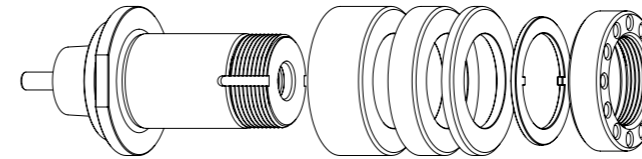
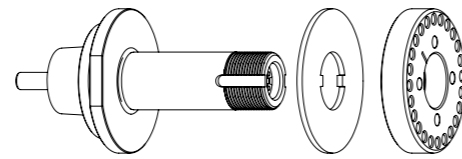
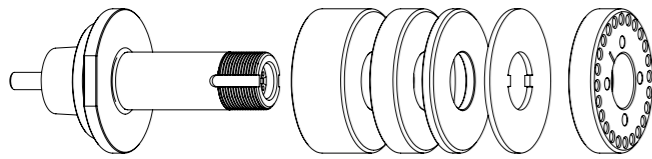

Delivered equipped:
Installation system, ring set $\varnothing 50$ mm, lock washer and clamping nut ANCA balancing hole

Delivered equipped:
Installation system, lock washer and clamping nut ANCA balancing hole

Delivered equipped:
Installation system, ring set $\varnothing 50$ mm, lock washer and clamping nut ANCA balancing hole

Delivered equipped:
Installation system, lock washer and clamping nut ANCA balancing hole

Order No.	HSK	d	L	Ring set $\varnothing 50$ mm		
				B20	B10	B4
300023012	HSK-F40	20	55	1	1	3
300023022	HSK-F40	20	72	2	1	2
300023032	HSK-F40	20	85	2	2	3
300023042	HSK-F40	20	95	3	1	3

Order No.	HSK	d	L
300023011	HSK-F40	20	55
300023021	HSK-F40	20	72
300023031	HSK-F40	20	85
300023041	HSK-F40	20	95

Order No.	HSK	d	L	Ring set $\varnothing 50$ mm		
				B20	B10	B4
300023112	HSK-F40	31,75	55	1	1	3
300023122	HSK-F40	31,75	72	2	1	2
300023132	HSK-F40	31,75	85	2	2	3
300023142	HSK-F40	31,75	95	3	1	3

Order No.	HSK	d	L
300023111	HSK-F40	31,75	55
300023121	HSK-F40	31,75	72
300023131	HSK-F40	31,75	85
300023141	HSK-F40	31,75	95

Accessories ANCA grinding wheel adapter manual HSK-F40 // Shaft $\varnothing 20$ mm // Ring set $\varnothing 50$ mm

Accessories ANCA grinding wheel adapter manual HSK-F40 // Shaft $\varnothing 31,75$ mm (1¼) // Ring set $\varnothing 50$ mm

Order No.	Name	
350050050	Assembly device HSK40 $\varnothing 40$	
350040010	Clamping nut wrench PC27 for $\varnothing 20$	
350040011	Clamping nut wrench PC27 for $\varnothing 20$	

Order No.	Name	
350011020	Spacer ring $\varnothing 50$ x $\varnothing 20$ x 20	
350011010	Spacer ring $\varnothing 50$ x $\varnothing 20$ x 10	
350011004	Spacer ring $\varnothing 50$ x $\varnothing 20$ x 4	
350030010	Lock washer $\varnothing 50$ x $\varnothing 20$ x 2	
350020051	Clamping nut ANCA $\varnothing 50$ x 9,5 M20 x 1	

Order No.	Name	
350050050	Assembly device HSK40 $\varnothing 40$	
350040030	Clamping nut wrench PC39 for ANCA nut	
350020027	*Balancing weight pair for clamping nut $\varnothing 47$ // 70gmm	

Order No.	Name	
350011120	Spacer ring $\varnothing 50$ x $\varnothing 31,75$ x 20	
350011110	Spacer ring $\varnothing 50$ x $\varnothing 31,75$ x 10	
350011104	Spacer ring $\varnothing 50$ x $\varnothing 31,75$ x 4	
350030040	Lock washer $\varnothing 43$ x $\varnothing 32$ x 2	
350020050	Clamping nut ANCA balancing hole $\varnothing 47$ x 12 M31,5 x 1,5	
350020026	*Clamping nut with balancing option $\varnothing 47$ x 12 M31,5 x 1,5	

For ANCA tool grinding machines with ring set $\varnothing 50$ mm
with integrated clamping and press-off system M6 clamping screw

For ANCA tool grinding machines with ring set $\varnothing 50$ mm

GWA manual HSK-F40 // $\varnothing 32$ mm // RS $\varnothing 50$ mm

GWA manual HSK-F40 // $\varnothing 32$ mm // without RS

GWA manual HSK-F40 // $\varnothing 20$ mm // RS $\varnothing 50$ mm

GWA manual HSK-F40 // $\varnothing 20$ mm // without RS

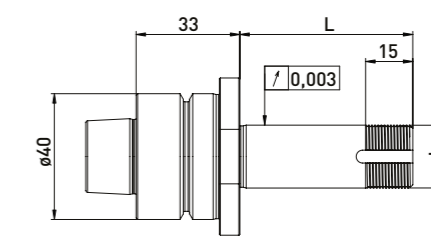
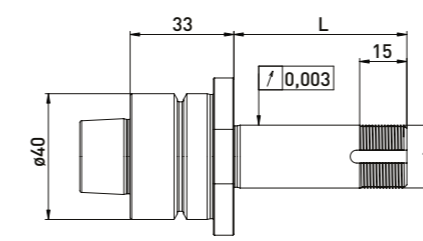
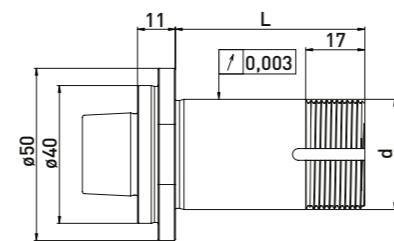
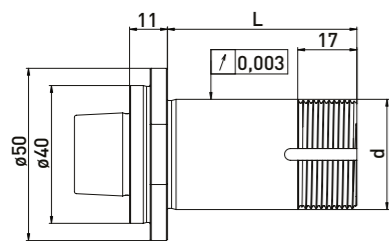
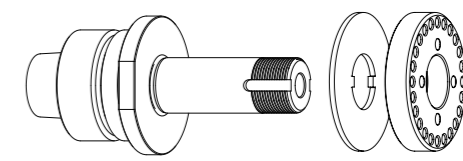
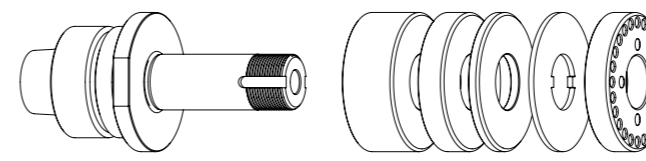
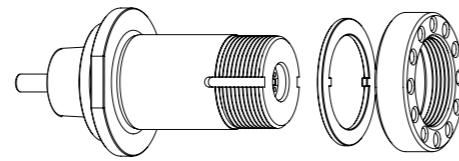
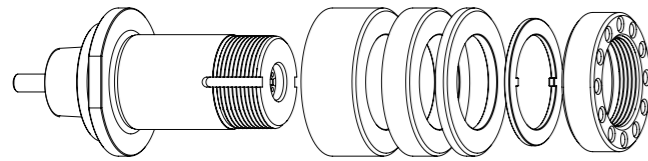

Delivered equipped:
Installation system, ring set $\varnothing 50$ mm, lock washer and clamping nut ANCA balancing hole

Delivered equipped:
Installation system, lock washer and clamping nut ANCA balancing hole

Delivered equipped:
Ring set $\varnothing 50$ mm, lock washer and clamping nut ANCA with balancing hole

Delivered equipped:
Lock washer and clamping nut ANCA with balancing hole

Order No.	HSK	d	L	Ring set $\varnothing 50$ mm		
				B20	B10	B4
300023212	HSK-F40	32	55	1	1	3
300023222	HSK-F40	32	72	2	1	2
300023232	HSK-F40	32	85	2	2	3
300023242	HSK-F40	32	95	3	1	3

Order No.	HSK	d	L
300023211	HSK-F40	32	55
300023221	HSK-F40	32	72
300023231	HSK-F40	32	85
300023241	HSK-F40	32	95

Order No.	HSK	d	L	Ring set $\varnothing 50$ mm		
				B20	B10	B4
300025012	HSK-F40	20	55	1	1	3
300025022	HSK-F40	20	72	2	1	2
300025032	HSK-F40	20	85	2	2	3
300025042	HSK-F40	20	95	3	1	3

Order No.	HSK	d	L
300025011	HSK-F40	20	55
300025021	HSK-F40	20	72
300025031	HSK-F40	20	85
300025041	HSK-F40	20	95

Accessories ANCA grinding wheel adapter manual HSK-F40 // Shaft $\varnothing 32$ mm // Ring set $\varnothing 50$ mm

Accessories ANCA grinding wheel adapter manual HSK-F40 // Shaft $\varnothing 20$ mm // Ring set $\varnothing 50$ mm

Order No.	Name	
350050050	Assembly device HSK40 $\varnothing 40$	
350040030	Clamping nut wrench PC39 for ANCA nut	
350020027	*Balancing weight pair for clamping nut $\varnothing 47$ // 70gmm	

Order No.	Name	
350011220	Spacer ring $\varnothing 50$ x $\varnothing 32$ x 20	
350011210	Spacer ring $\varnothing 50$ x $\varnothing 32$ x 10	
350011204	Spacer ring $\varnothing 50$ x $\varnothing 32$ x 4	
350030040	Lock washer $\varnothing 43$ x $\varnothing 32$ x 2	
350020050	Clamping nut ANCA balancing hole $\varnothing 47$ x 12 M31,5 x 1,5	
350020026	*Clamping nut with balancing option $\varnothing 47$ x 12 M31,5 x 1,5	

Order No.	Name	
350050050	Assembly device HSK40 $\varnothing 40$	
350040010	*Clamping nut wrench PC27 for $\varnothing 20$	
350040011	*Clamping nut wrench PC27 for $\varnothing 20$	
350020021	*Balancing weight pair for clamping nut $\varnothing 50$ // 100gmm	

Order No.	Name	
350011020	Spacer ring $\varnothing 50$ x $\varnothing 20$ x 20	
350011010	Spacer ring $\varnothing 50$ x $\varnothing 20$ x 10	
350011004	Spacer ring $\varnothing 50$ x $\varnothing 20$ x 4	
350030010	Lock washer $\varnothing 50$ x $\varnothing 20$ x 2	
350020051	Clamping nut ANCA $\varnothing 50$ x 9,5 M20 x 1	
350020020	*Clamping nut with balancing option $\varnothing 50$ x 8,5 M20 x 1,0	

ANCA automatic HSK-F40 // Shaft $\varnothing 31,75$ mm (1¼) // RS $\varnothing 50$ mm

For ANCA tool grinding machines with ring set $\varnothing 50$ mm

GWA manual HSK-F40 // $\varnothing 32$ mm // RS $\varnothing 50$ mm

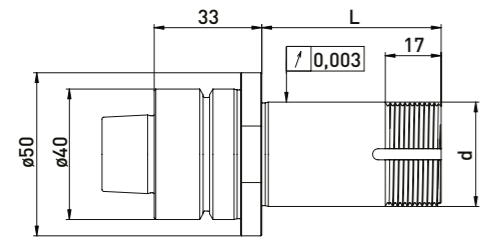
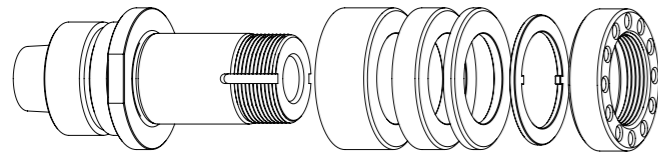

Delivered equipped:

Ring set $\varnothing 50$ mm, lock washer and clamping nut ANCA balancing hole

Ring set $\varnothing 50$ mm

Order No.	HSK	d	L	B20	B10	B4
300025112	HSK-F40	31,75	55	1	1	3
300025122	HSK-F40	31,75	72	2	1	2
300025132	HSK-F40	31,75	85	2	2	3
300025142	HSK-F40	31,75	95	3	1	3

GWA manual HSK-F40 // $\varnothing 32$ mm // without RS

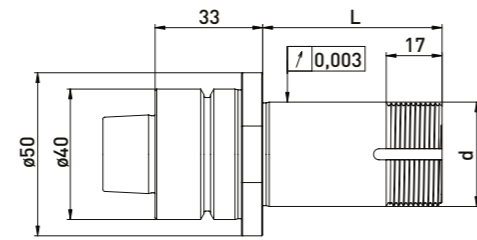
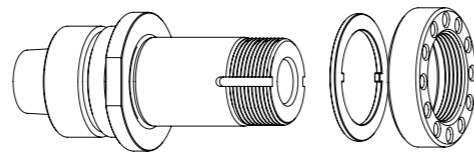

Delivered equipped:

Lock washer and clamping nut ANCA balancing hole

Order No.	HSK	d	L
300025111	HSK-F40	31,75	55
300025121	HSK-F40	31,75	72
300025131	HSK-F40	31,75	85
300025141	HSK-F40	31,75	95

Accessories ANCA grinding wheel adapter manual HSK-F40 // Shaft $\varnothing 20$ mm // Ring set $\varnothing 50$ mm

Order No.	Name	
350050010	Universal assembly device $\varnothing 50$	
350040030	Clamping nut wrench PC39 for ANCA nut	
350020027	*Balancing weight pair for clamping nut $\varnothing 47$ // 70gmm	

Order No.	Name	
350011120	Spacer ring $\varnothing 50$ x $\varnothing 31,75$ x 20	
350011110	Spacer ring $\varnothing 50$ x $\varnothing 31,75$ x 10	
350011104	Spacer ring $\varnothing 50$ x $\varnothing 31,75$ x 4	
350030040	Lock washer $\varnothing 43$ x $\varnothing 32$ x 2	
350020050	Clamping nut ANCA balancing hole $\varnothing 47$ x 12 M31,5 x 1,5	
350020026	*Clamping nut with balancing option $\varnothing 47$ x 12 M31,5 x 1,5	

ANCA automatic HSK-F40 // Shaft $\varnothing 32$ mm // RS $\varnothing 50$ mm

For ANCA tool grinding machines with ring set $\varnothing 50$ mm

GWA automatic HSK-F40 // $\varnothing 32$ mm // RS $\varnothing 50$ mm

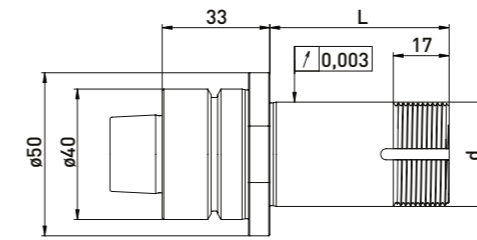
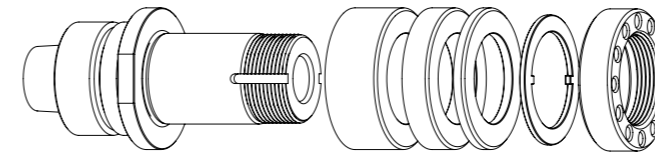

Delivered equipped:

Ring set $\varnothing 50$ mm, lock washer and clamping nut ANCA balancing hole

Ring set $\varnothing 50$ mm

Order No.	HSK	d	L	B20	B10	B4
300025212	HSK-F40	32	55	1	1	3
300025222	HSK-F40	32	72	2	1	2
300025232	HSK-F40	32	85	2	2	3
300025242	HSK-F40	32	95	3	1	3

GWA automatic HSK-F40 // $\varnothing 32$ mm // without RS

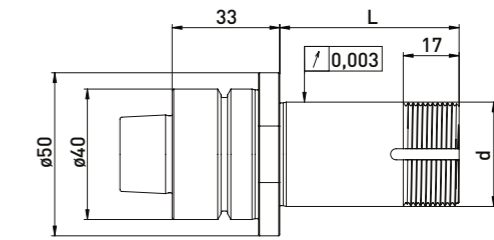
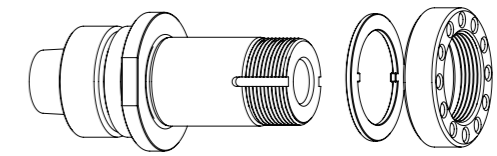

Delivered equipped:

Lock washer and clamping nut ANCA balancing hole

Order No.	HSK	d	L
300025211	HSK-F40	32	55
300025221	HSK-F40	32	72
300025231	HSK-F40	32	85
300025241	HSK-F40	32	95

Accessories ANCA grinding wheel adapter automatic HSK-F40 // Shaft $\varnothing 32$ mm // Ring set $\varnothing 50$ mm

Order No.	Name	
350050010	Universal assembly device $\varnothing 50$	
350040030	Clamping nut wrench PC39 for ANCA nut	
350020027	*Balancing weight pair for clamping nut $\varnothing 47$ // 70gmm	

Order No.	Name	
350011220	Spacer ring $\varnothing 50$ x $\varnothing 32$ x 20	
350011210	Spacer ring $\varnothing 50$ x $\varnothing 32$ x 10	
350011204	Spacer ring $\varnothing 50$ x $\varnothing 32$ x 4	
350030040	Lock washer $\varnothing 43$ x $\varnothing 32$ x 2	
350020050	Clamping nut ANCA balancing hole $\varnothing 47$ x 12 M31,5 x 1,5	
350020026	*Clamping nut with balancing option $\varnothing 47$ x 12 M31,5 x 1,5	

ANCA automatic HSK-F50 // Shaft $\varnothing 20$ mm // RS $\varnothing 50$ mm

For ANCA tool grinding machines with ring set $\varnothing 50$ mm

GWA automatic HSK-F50 // $\varnothing 20$ mm // RS $\varnothing 50$ mm

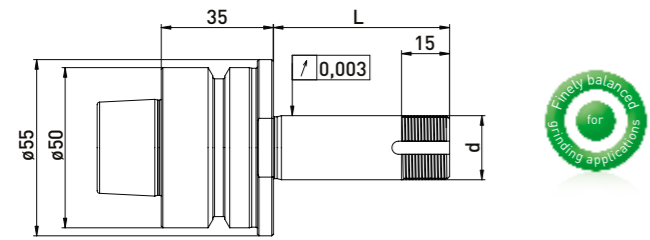
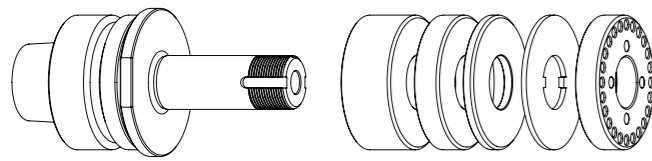

Delivered equipped:

Ring set $\varnothing 50$ mm, lock washer and clamping nut ANCA balancing hole

Order No.	HSK	d	L	Ring set $\varnothing 50$ mm		
				B20	B10	B4
300024012	HSK-F50	20	55	1	1	3
300024022	HSK-F50	20	72	2	1	2
300024032	HSK-F50	20	85	2	2	3
300024042	HSK-F50	20	95	3	1	3

GWA automatic HSK-F50 // $\varnothing 20$ mm // without RS

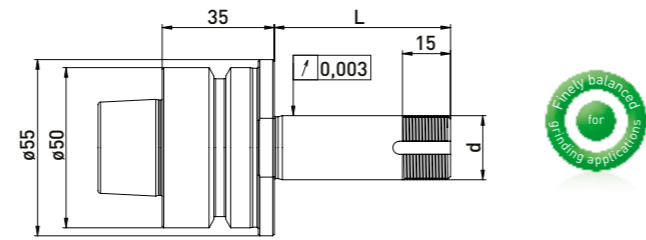
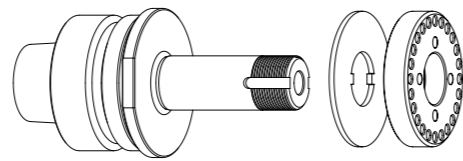

Delivered equipped:

Lock washer and clamping nut ANCA balancing hole

Order No.	HSK	d	L
300024011	HSK-F50	20	55
300024021	HSK-F50	20	72
300024031	HSK-F50	20	85
300024041	HSK-F50	20	95

Accessories ANCA grinding wheel adapter automatic HSK-F50 // Shaft $\varnothing 20$ mm // Ring set $\varnothing 50$ mm

Order No.	Name	Order No.	Name
350050010	Universal assembly device $\varnothing 50$	350011020	Spacer ring $\varnothing 50 \times \varnothing 20 \times 20$
350040010	*Clamping nut wrench PC27 for $\varnothing 20$	350011010	Spacer ring $\varnothing 50 \times \varnothing 20 \times 10$
350040011	*Clamping nut wrench PC27 for $\varnothing 20$	350011004	Spacer ring $\varnothing 50 \times \varnothing 20 \times 4$
350020021	*Balancing weight pair for clamping nut $\varnothing 50 // 100$ gmm	350030010	Lock washer $\varnothing 50 \times \varnothing 20 \times 2$
		350020051	Clamping nut ANCA $\varnothing 50 \times 9,5$ M20 x 1
		350020020	*Clamping nut with balancing option $\varnothing 50 \times 8,5$ M20 x 1,0 PC27

ANCA automatic HSK-F50 // Shaft $\varnothing 31,75$ mm ($1\frac{1}{4}$) // RS $\varnothing 50$ mm

For ANCA tool grinding machines with ring set $\varnothing 50$ mm

GWA automatic HSK-F50 // $\varnothing 31,75$ mm ($1\frac{1}{4}$) // RS $\varnothing 50$ mm

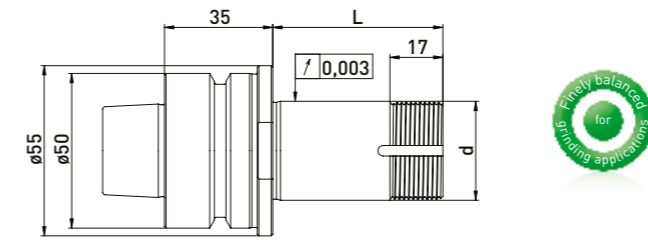
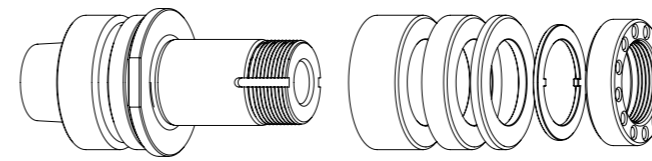

Delivered equipped:

Ring set $\varnothing 50$ mm, lock washer and clamping nut ANCA balancing hole

Order No.	HSK	d	L	Ring set $\varnothing 50$ mm		
				B20	B10	B4
300024112	HSK-F50	31,75	55	1	1	3
300024122	HSK-F50	31,75	72	2	1	2
300024132	HSK-F50	31,75	85	2	2	3
300024142	HSK-F50	31,75	95	3	1	3

GWA automatic HSK-F50 // $\varnothing 31,75$ mm // without RS

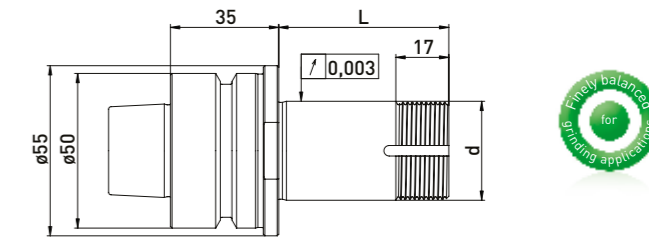
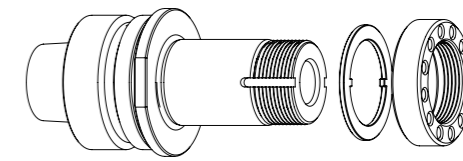

Delivered equipped:

Lock washer and clamping nut ANCA balancing hole

Order No.	HSK	d	L
300024111	HSK-F50	31,75	55
300024121	HSK-F50	31,75	72
300024131	HSK-F50	31,75	85
300024141	HSK-F50	31,75	95

Accessories ANCA grinding wheel adapter automatic HSK-F50 // Shaft $\varnothing 31,75$ mm ($1\frac{1}{4}$) // Ring set $\varnothing 50$ mm

Order No.	Name	Order No.	Name
350050010	Universal assembly device $\varnothing 50$	350011120	Spacer ring $\varnothing 50 \times \varnothing 31,75 \times 20$
350040030	Clamping nut wrench PC39 for ANCA nut	350011110	Spacer ring $\varnothing 50 \times \varnothing 31,75 \times 10$
350020027	*Balancing weight pair for clamping nut $\varnothing 47 // 70$ gmm	350011104	Spacer ring $\varnothing 50 \times \varnothing 31,75 \times 4$
		350030040	Lock washer $\varnothing 43 \times \varnothing 32 \times 2$
		350020050	Clamping nut ANCA $\varnothing 47 \times 12$ M31,5x1,5
		350020026	*Clamping nut with balancing option $\varnothing 47 \times 12$ M31,5 x 1,5

ANCA automatic HSK-F50 // Shaft $\varnothing 32$ mm // RS $\varnothing 50$ mm

For ANCA tool grinding machines with ring set $\varnothing 50$ mm

GWA automatic HSK-F50 // $\varnothing 32$ mm // RS $\varnothing 50$ mm

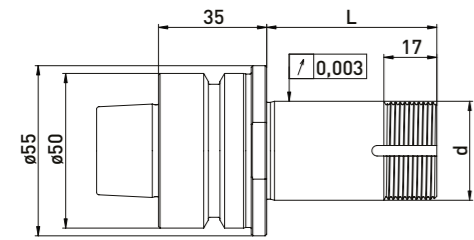
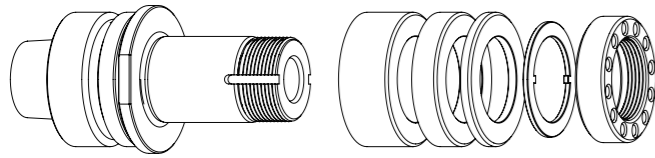

Delivered equipped:

Ring set $\varnothing 50$ mm, lock washer and clamping nut ANCA balancing hole

Ring set $\varnothing 50$ mm

Order No.	HSK	d	L	B20	B10	B4
300024212	HSK-F50	32	55	1	1	3
300024222	HSK-F50	32	72	2	1	2
300024232	HSK-F50	32	85	2	2	3
300024242	HSK-F50	32	95	3	1	3

GWA automatic HSK-F50 // $\varnothing 32$ mm // without RS

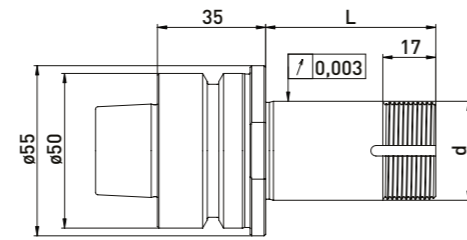
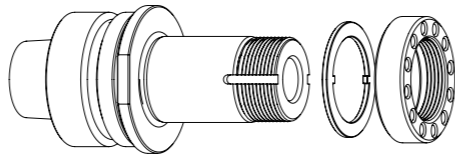

Delivered equipped:

Lock washer and clamping nut ANCA balancing hole

Order No.	HSK	d	L
300024211	HSK-F50	32	55
300024221	HSK-F50	32	72
300024231	HSK-F50	32	85
300024241	HSK-F50	32	95

Accessories ANCA grinding wheel adapter automatic HSK-F50 // Shaft $\varnothing 32$ mm // Ring set $\varnothing 50$ mm

Order No.	Name	
350050010	Universal assembly device $\varnothing 50$	
350040030	Clamping nut wrench PC39 for ANCA nut	
350020027	*Balancing weight pair for clamping nut $\varnothing 47$ // 70gmm	

Order No.	Name	
350011220	Spacer ring $\varnothing 50$ x $\varnothing 32$ x 20	
350011210	Spacer ring $\varnothing 50$ x $\varnothing 32$ x 10	
350011204	Spacer ring $\varnothing 50$ x $\varnothing 32$ x 4	
350030040	Lock washer $\varnothing 43$ x $\varnothing 32$ x 2	
350020050	Clamping nut ANCA balancing hole $\varnothing 47$ x 12 M31,5 x 1,5	
350020026	*Clamping nut with balancing option $\varnothing 47$ x 12 M31,5 x 1,5	

ANCA similar SK40 with flat contact face

For ANCA tool grinding machines

GWA similar SK40 with flat contact face

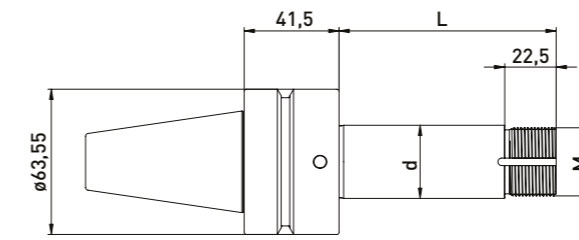
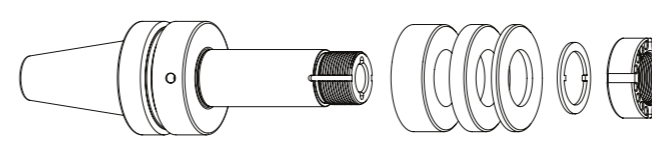

Delivered equipped:

Ring set, lock washer and clamping nut with balancing option

Ring set

Order No.	Fine thread	d	L	B20	B10	B4
300026052	M20 x 1,5	20	95	2	2	4
300026152	M30 x 1,5	31,75	95	2	2	4
300026252	M30 x 1,5	32	95	2	2	4
300026952	M50 x 1,5	50,8	95	2	2	4

Accessories ANCA grinding wheel adapter similar SK40 with flat contact face

Order No.	Name	
250000552	Lock washer $\varnothing 37$ x $\varnothing 20$ x 2	
250000940	Lock washer $\varnothing 40$ x $\varnothing 30$ x 2	
250000550	Lock washer $\varnothing 64$ x $\varnothing 50,2$ x 2	

Accessories GWA similar SK40 with flat contact face

Order No.	Name	
350011020	Spacer ring $\varnothing 50$ x $\varnothing 20$ x 20	
350011010	Spacer ring $\varnothing 50$ x $\varnothing 20$ x 10	
350011004	Spacer ring $\varnothing 50$ x $\varnothing 20$ x 4	
350011420	Spacer ring $\varnothing 60$ x $\varnothing 31,75$ x 20	
350011410	Spacer ring $\varnothing 60$ x $\varnothing 31,75$ x 10	
350011404	Spacer ring $\varnothing 60$ x $\varnothing 31,75$ x 4	
350011320	Spacer ring $\varnothing 60$ x $\varnothing 32$ x 20	
350011310	Spacer ring $\varnothing 60$ x $\varnothing 32$ x 10	
350011304	Spacer ring $\varnothing 60$ x $\varnothing 32$ x 4	
250000549	Spacer ring $\varnothing 75$ x $\varnothing 50,8$ x 20	
250000548	Spacer ring $\varnothing 75$ x $\varnothing 50,8$ x 10	
250000547	Spacer ring $\varnothing 75$ x $\varnothing 50,8$ x 4	

Order No.	Name	
250000553	Clamping nut with balancing option $\varnothing 40$ x 17 M20 x 1,5	
250000485	Clamping nut with balancing option $\varnothing 45$ x 17 M30 x 1,5	
250000551	Clamping nut with balancing option $\varnothing 70$ x 19 M50 x 1,5	
350300131	Hook wrench 40-42 mm	
350300132	Hook wrench 45-50 mm	
350300133	Hook wrench 68-75 mm	

Deckel/ISOG HSK-F50 // Shaft $\varnothing 20$ mm // RS $\varnothing 35$ mm

For Deckel/ISOG tool grinding machines with ring set $\varnothing 35$ mm

GWA HSK-F50 // $\varnothing 20$ mm // RS $\varnothing 35$ mm

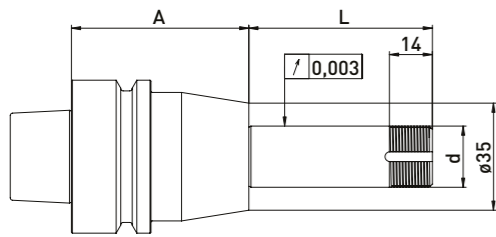
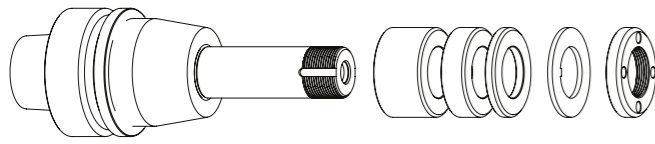

Delivered equipped:
Ring set $\varnothing 35$ mm, lock washer and clamping nut

GWA HSK-F50 // $\varnothing 20$ mm // without RS

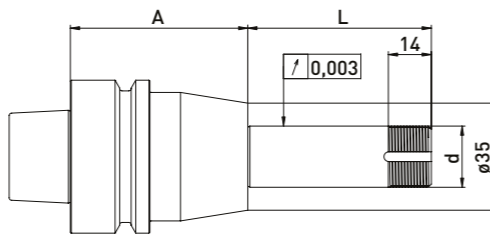
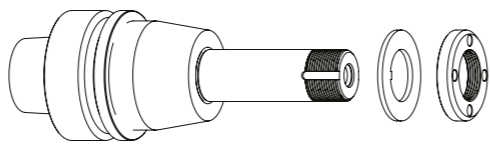

Delivered equipped:
Lock washer and clamping nut

Ring set $\varnothing 35$ mm

Order No.	HSK	d	L	A	B20	B10	B4
300032512	HSK-F50	20	48	38	-	2	4
300032522	HSK-F50	20	60	58	1	1	4
300032532	HSK-F50	20	90	58	2	2	4

Order No.	HSK	d	L	A
300032511	HSK-F50	20	48	38
300032521	HSK-F50	20	60	58
300032531	HSK-F50	20	90	58

Deckel/ISOG HSK-F50 // Shaft $\varnothing 20$ mm // RS $\varnothing 50$ mm

For Deckel/ISOG tool grinding machines with ring set $\varnothing 50$ mm

GWA HSK-F50 // $\varnothing 20$ mm // RS $\varnothing 50$ mm

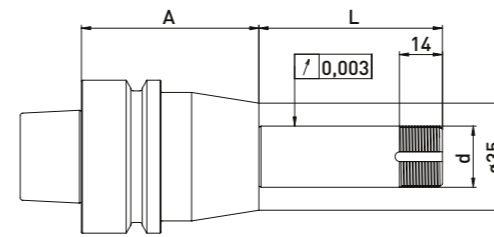
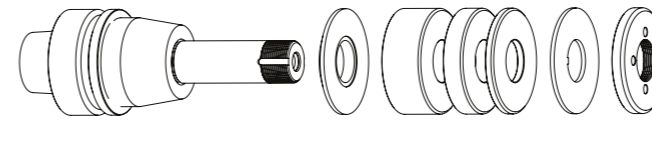

Delivered equipped:
Reducing washer, ring set $\varnothing 50$ mm, lock washer and clamping nut

GWA HSK-F50 // $\varnothing 20$ mm // without RS

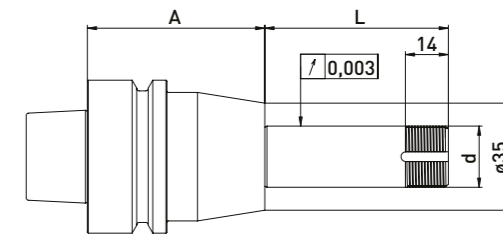
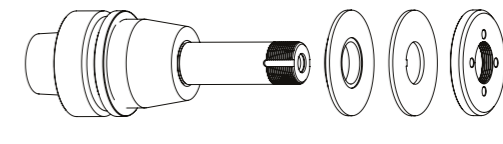

Delivered equipped:
Reducing washer, lock washer and clamping nut

Ring set $\varnothing 50$ mm

Order No.	HSK	d	L	A	B20	B10	B4
300032012	HSK-F50	20	48	38	-	2	3
300032022	HSK-F50	20	60	58	1	1	3
300032032	HSK-F50	20	90	58	2	2	3

Order No.	HSK	d	L	A
300032011	HSK-F50	20	48	38
300032021	HSK-F50	20	60	58
300032031	HSK-F50	20	90	58

Accessories Deckel/ISOG grinding wheel adapter HSK-F50 // Shaft $\varnothing 20$ mm // Ring set 35 mm

Order No.	Name	
350050010	Universal assembly device $\varnothing 50$	
350050020	Assembly device Deckel/ISOG	
350040010	Clamping nut wrench PC27 for $\varnothing 20$	
350040011	Clamping nut wrench PC27 for $\varnothing 20$	
350040040	*Clamping nut wrench PC29 for $\varnothing 20$ for clamping nut with balancing option	
350040041	*Clamping nut wrench PC29 for $\varnothing 20$	
350020081	*Balancing weight pair for clamping nut $\varnothing 35$ // 40gmm	

Order No.	Name	
350012020	Spacer ring $\varnothing 35$ x $\varnothing 20$ x 20	
350012010	Spacer ring $\varnothing 35$ x $\varnothing 20$ x 10	
350012004	Spacer ring $\varnothing 35$ x $\varnothing 20$ x 4	
250001397	Lock washer $\varnothing 35$ x 1,5	
350020030	Clamping nut $\varnothing 35$ x 6 M20 x 1 PC27	
114050034	Clamping nut Deckel/ISOG $\varnothing 35$ x 7 PC29	
350020080	*Clamping nut with balancing option $\varnothing 35$ x $\varnothing 40$ x 8 x M20 x 1 PC29	

Accessories Deckel/ISOG grinding wheel adapter HSK-F50 // Shaft $\varnothing 20$ mm // Ring set 50 mm

Order No.	Name	
350050010	Universal assembly device $\varnothing 50$	
350050020	Assembly device Deckel/ISOG	
350040010	*Clamping nut wrench PC27 for $\varnothing 20$	
350040011	*Clamping nut wrench PC27 for $\varnothing 20$	
350020021	*Balancing weight pair for clamping nut $\varnothing 50$ // 100gmm	

Order No.	Name	
350011020	Spacer ring $\varnothing 50$ x $\varnothing 20$ x 20	
350011010	Spacer ring $\varnothing 50$ x $\varnothing 20$ x 10	
350011004	Spacer ring $\varnothing 50$ x $\varnothing 20$ x 4	
250001482	Lock washer $\varnothing 50$ x 2	
350020060	Clamping nut $\varnothing 50$ x 6 x M20 x 1 PC27	
350015003	Support washer $\varnothing 50$ x $\varnothing 75$ x $\varnothing 20$ x 6	
350020020	*Clamping nut with balancing option $\varnothing 50$ x 8,5 M20 x 1,0 PC27	

EWAG ø80 mm // Shaft ø20 mm // RS ø35 mm

For EWAG tool grinding machines with ring set ø35 mm

GWA ø80 mm // ø20 mm // RS ø35 mm

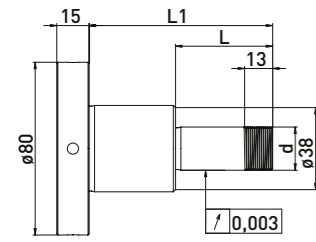
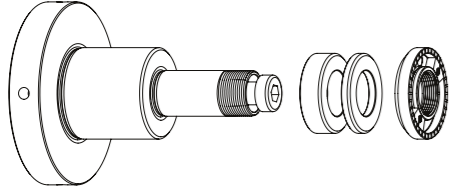

Delivered equipped:

Ring set ø35 mm, clamping nut with balancing weights and M10 clamping screw

Order No.	d	L	L1	Ring set ø35 mm	
				B 10	B 4
300140012	20	45	85	2	3

EWAG ø80 mm // Shaft ø20 mm // RS ø35 mm

For EWAG tool grinding machines with ring set ø35 mm

GWA ø80 mm // ø20 mm // RS ø35 mm

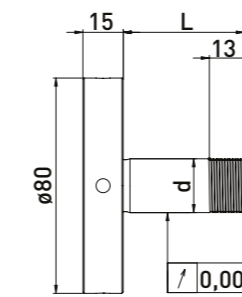
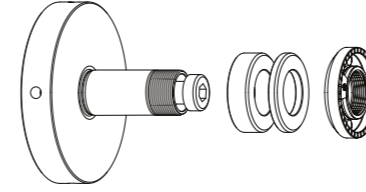

Delivered equipped:

Ring set ø35 mm, clamping nut with balancing weights and M10 clamping screw

Order No.	d	L	Ring set ø35 mm	
			B 10	B 4
300141012	20	20	-	2
300141022	20	45	2	3

Accessories EWAG grinding wheel adapter 80 mm // Shaft ø20 mm // Ring set ø35 mm

Order No.	Name	
350020081	*Balancing weight pair for clamping nut ø35 // 40gmm	
350040040	*Clamping nut wrench PC29 for ø20 for clamping nut with balancing option	
350040041	*Clamping nut wrench PC29 for ø20	

Order No.	Name	
350012004	Spacer ring ø35 x ø20 x 4	
350012010	Spacer ring ø35 x ø20 x 10	
350020080	*Clamping nut with balancing option ø35 x ø40 x 8 x M20 x 1 PC29	

Accessories EWAG grinding wheel adapter 80 mm // Shaft ø20 mm // Ring set ø35 mm

Order No.	Name	
350020081	*Balancing weight pair for clamping nut ø35 // 40gmm	
350040040	*Clamping nut wrench PC29 for ø20 for clamping nut with balancing option	
350040041	*Clamping nut wrench PC29 for ø20	

Order No.	Name	
350012004	Spacer ring ø35 x ø20 x 4	
350012010	Spacer ring ø35 x ø20 x 10	
350020080	*Clamping nut with balancing option ø35 x ø40 x 8 x M20 x 1 PC29	

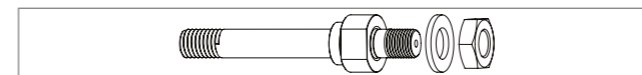

Order No.	Name
300149001	M10 adapter screw to ø10 EWAG M10 for article 300140012
300149002	M10 adapter screw to ø10 EWAG M10 for article 300141022

*related items

EWAG $\varnothing 80$ mm // Shaft $\varnothing 40$ mm // RS 70 mm

For EWAG tool grinding machines with ring set $\varnothing 70$ mm

GWA $\varnothing 80$ mm // $\varnothing 40$ mm // RS 70 mm

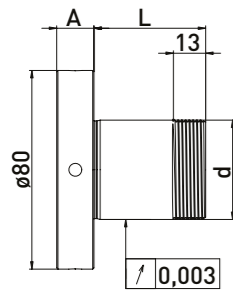
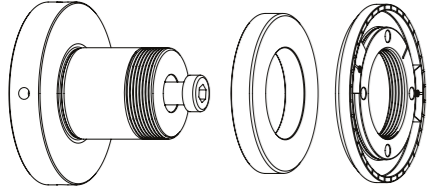

Delivered equipped:

Spacer ring $\varnothing 70$ mm, clamping nut with balancing weights and M10 clamping screw

Ring set $\varnothing 70$ mm				
Order No.	d	L	A	B 12
300140242	40	45	15	1

GWA $\varnothing 80$ mm // $\varnothing 40$ mm // without RS

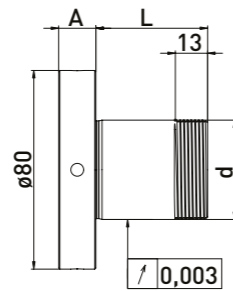
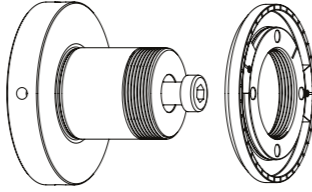

Delivered equipped:

Clamping nut with balancing weights and M10 clamping screw

Order No.	d	L	A
300140212	40	20	15
300140222	40	20	30
300140232	40	20	49

Accessories EWAG grinding wheel adapter $\varnothing 80$ mm // Shaft $\varnothing 40$ mm // RS 70 mm

Order No.	Name	Order No.	Name
350020082	*Balancing weight pair for clamping nut $\varnothing 78$ EWAG	350014012	Spacer ring $\varnothing 70$ x $\varnothing 40$ x 12
		350020025	*Clamping nut with balancing option $\varnothing 78$ x 8,5 x M40x1,5

EWAG $\varnothing 125$ mm // Shaft $\varnothing 50$ mm

For EWAG tool grinding machines

GWA $\varnothing 125$ // $\varnothing 50$ mm

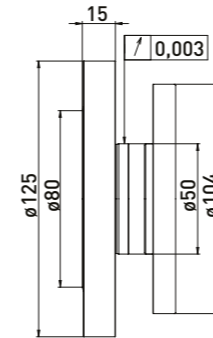
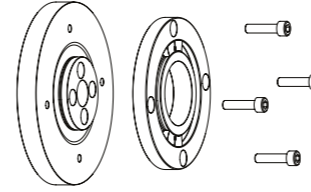

Delivered equipped:

Flange and counter-flange with balancing weights and 4pc. M6x25 clamping screws

Order No.	Name
300140311	Grinding wheel adapter EWAG $\varnothing 125$ x $\varnothing 50$ x A15

Accessories EWAG grinding wheel adapter $\varnothing 125$ // Shaft $\varnothing 50$ mm

Order No.	Name
350020082	Balancing weight pair for clamping nut $\varnothing 78$ EWAG

Haas Internal taper $\varnothing 31,75$ mm (1¼) // Shaft $\varnothing 20$ mm // RS $\varnothing 35$ mm

For Haas tool grinding machines with ring set $\varnothing 35$ mm

GWA Internal taper $\varnothing 31,75$ mm (1¼) // $\varnothing 20$ mm // RS $\varnothing 35$ mm

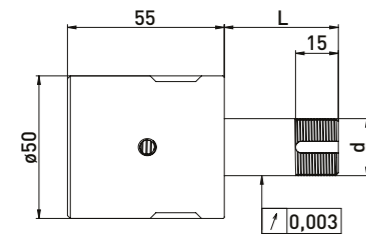
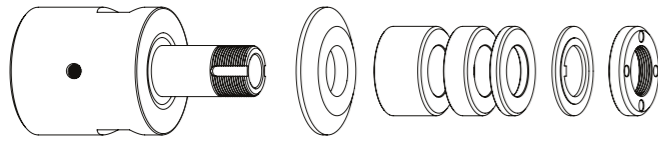

Delivered equipped:

Installation skit, reducing washer, ring set $\varnothing 35$ mm, lock washer and clamping nut

Ring set $\varnothing 35$ mm

Order No.	Internal taper	d	L	B20	B10	B4
300091512	31,75	20	40	-	1	3
300091522	31,75	20	60	1	1	3
300091532	31,75	20	100	2	3	3

GWA Internal taper $\varnothing 31,75$ mm (1¼) // $\varnothing 20$ mm // $\varnothing 20$ mm

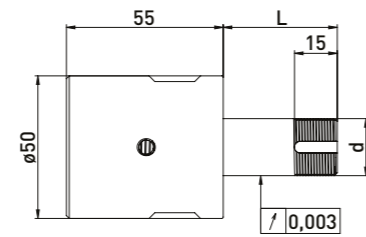
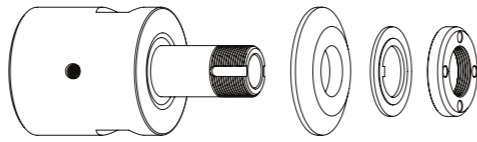

Delivered equipped:

Installation kit, reducing washer, lock washer and clamping nut

Order No.	Internal taper	d	L
300091511	31,75	20	40
300091521	31,75	20	60
300091531	31,75	20	100

Haas Internal taper $\varnothing 31,75$ mm (1¼) // Shaft $\varnothing 20$ mm // RS $\varnothing 50$ mm

For Haas tool grinding machines with ring set $\varnothing 50$ mm

GWA Internal taper $\varnothing 31,75$ mm (1¼) // $\varnothing 20$ mm // RS $\varnothing 50$ mm

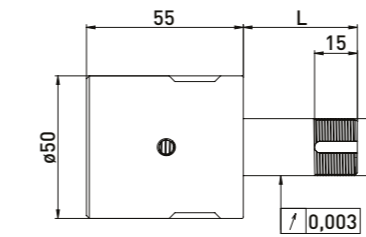
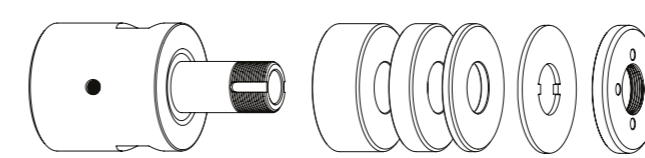

Delivered equipped:

Installation kit, ring set $\varnothing 50$ mm, lock washer and clamping nut

Ring set $\varnothing 50$ mm

Order No.	Internal taper	d	L	B20	B10	B4
300091012	31,75	20	40	-	1	4
300091022	31,75	20	60	1	1	4
300091032	31,75	20	100	2	3	4

GWA Internal taper $\varnothing 31,75$ mm (1¼) // $\varnothing 20$ mm // $\varnothing 20$ mm

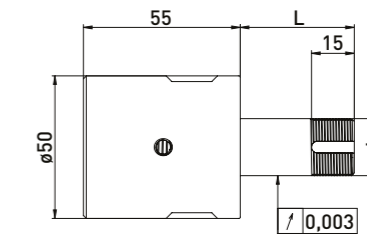
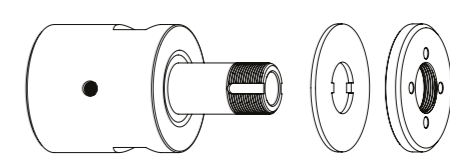

Delivered equipped:

Installation kit, lock washer and clamping nut

Order No.	Internal taper	d	L
300091011	31,75	20	40
300091021	31,75	20	60
300091031	31,75	20	100

Accessories Haas grinding wheel adapter Internal taper $\varnothing 31,75$ mm (1¼) // Shaft $\varnothing 20$ mm // Ring set 35 mm

Order No.	Name	
350050010	Universal assembly device $\varnothing 50$	
350040010	Clamping nut wrench PC27 for $\varnothing 20$	
350040011	Clamping nut wrench PC27 for $\varnothing 20$	
350040040	*Clamping nut wrench PC29 for $\varnothing 20$ for clamping nut with blancing option	
350040041	*Clamping nut wrench PC29 for $\varnothing 20$	
350020081	*Balancing weight pair for clamping nut $\varnothing 35$ // 40gmm	
300101002	Installation kit NCT63 Haas	
300101003	Assembly wrench for Installation kit NCT63 M20 x 1,5	

Order No.	Name	
350012020	Spacer ring $\varnothing 35$ x $\varnothing 20$ x 20	
350012010	Spacer ring $\varnothing 35$ x $\varnothing 20$ x 10	
350012004	Spacer ring $\varnothing 35$ x $\varnothing 20$ x 4	
350015001	Reducing washer $\varnothing 50$ x $\varnothing 35$ x $\varnothing 20$ x 6	
350030020	Lock washer $\varnothing 35$ x $\varnothing 20$ x 2	
350020030	Clamping nut $\varnothing 35$ x 6 M20 x 1 PC27	
350020080	*Clamping nut with balancing option $\varnothing 35$ x $\varnothing 40$ x 8 x M20 x1 PC29	
350015005	Support washer $\varnothing 35$ x $\varnothing 60$ x $\varnothing 20$ x 6	

Accessories Haas grinding wheel adapter Internal taper $\varnothing 31,75$ mm (1¼) // Shaft $\varnothing 20$ mm // Ring set 35 mm

Order No.	Name	
350050010	Universal assembly device $\varnothing 50$	
350040010	*Clamping nut wrench PC27 for $\varnothing 20$	
350040011	*Clamping nut wrench PC27 for $\varnothing 20$	
350020021	*Balancing weight pair for clamping nut $\varnothing 50$ // 100gmm	
300101002	Installation kit NCT63 Haas	
300101003	Assembly wrench for Installation kit NCT63 M20 x 1,5	

Order No.	Name	
350011020	Spacer ring $\varnothing 50$ x $\varnothing 20$ x 20	
350011010	Spacer ring $\varnothing 50$ x $\varnothing 20$ x 10	
350011004	Spacer ring $\varnothing 50$ x $\varnothing 20$ x 4	
350030010	Lock washer $\varnothing 50$ x $\varnothing 20$ x 2	
350020020	*Clamping nut with balancing option $\varnothing 50$ x 8,5 M20 x 1,0 PC27	
350015003	Support washer $\varnothing 50$ x $\varnothing 75$ x $\varnothing 20$ x 6	
350020060	Clamping nut $\varnothing 50$ x 6 x M20 x 1 PC27	

Haas HSK-E50 // Shaft \varnothing 20 mm // RS \varnothing 35 mm

For Haas tool grinding machines with ring set \varnothing 35 mm

GWA HSK-E50 // \varnothing 20 mm // RS \varnothing 35 mm

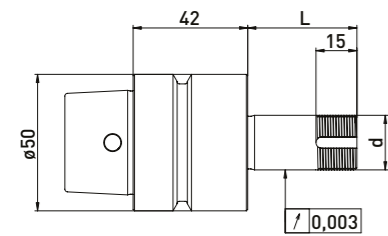
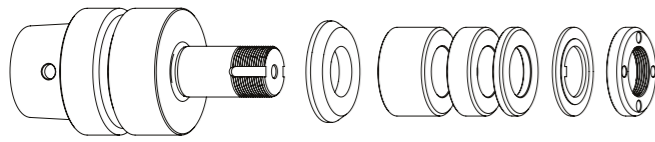

GWA HSK-E50 // \varnothing 20 mm // without RS

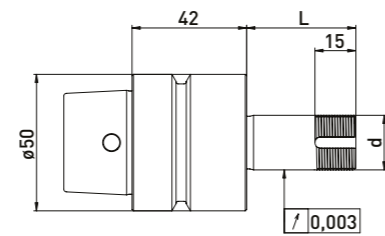
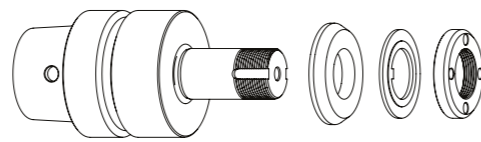

Delivered equipped:

Reducing washer, ring set \varnothing 35 mm, lock washer and clamping nut

Delivered equipped:

Reducing washer, lock washer and clamping nut

Order No.	HSK	d	L	Ring set \varnothing 35 mm		
				B20	B10	B4
300092512	HSK-E50	20	40	-	1	3
300092522	HSK-E50	20	60	1	1	3
300092532	HSK-E50	20	100	2	3	3

Order No.	HSK	d	L
300092511	HSK-E50	20	40
300092521	HSK-E50	20	60
300092531	HSK-E50	20	100

Haas HSK-E50 // Shaft \varnothing 20 mm // RS \varnothing 50 mm

For Haas tool grinding machines with ring set \varnothing 50 mm

GWA HSK-E50 // \varnothing 20 mm // RS \varnothing 50 mm

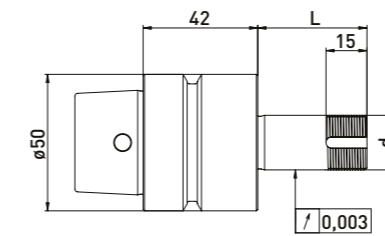
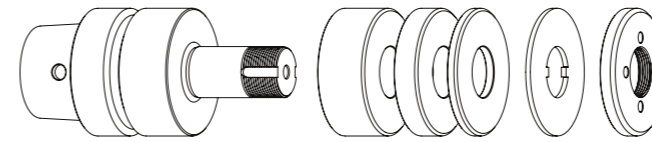

GWA HSK-E50 // \varnothing 20 mm // without RS

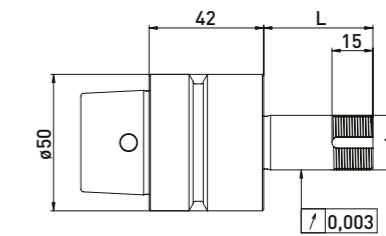
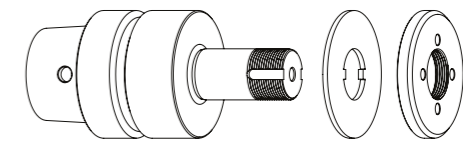

Delivered equipped:

Ring set \varnothing 50 mm, lock washer and clamping nut

Delivered equipped:

Lock washer and clamping nut

Order No.	HSK	d	L	Ring set \varnothing 50mm		
				B20	B10	B4
300092012	HSK-E50	20	40	-	1	4
300092022	HSK-E50	20	60	1	1	4
300092032	HSK-E50	20	100	2	3	4

Order No.	HSK	d	L
300092011	HSK-E50	20	40
300092021	HSK-E50	20	60
300092031	HSK-E50	20	100

Accessories Haas grinding wheel adapter HSK-E50 // Shaft \varnothing 20 mm // Ring set \varnothing 35 mm

Order No.	Name	
350050010	Universal assembly device \varnothing 50	
350040010	Clamping nut wrench PC27 for \varnothing 20	
350040011	Clamping nut wrench PC27 for \varnothing 20	
350040040	*Clamping nut wrench PC29 for \varnothing 20 for clamping nut with blancing option	
350040041	*Clamping nut wrench PC29 for \varnothing 20	
350020081	*Balancing weight pair for clamping nut \varnothing 35 // 40gmm	

Order No.	Name	
350012020	Spacer ring \varnothing 35 x \varnothing 20 x 20	
350012010	Spacer ring \varnothing 35 x \varnothing 20 x 10	
350012004	Spacer ring \varnothing 35 x \varnothing 20 x 4	
350015001	Reducing washer \varnothing 50 x \varnothing 35 x \varnothing 20 x 6	
350030020	Lock washer \varnothing 35 x \varnothing 20 x 2	
350020030	Clamping nut \varnothing 35 x 6 M20 x 1 PC27	
350020080	*Clamping nut with balancing option \varnothing 35 x \varnothing 40 x 8 x M20 x 1 PC29	
350015005	Support washer \varnothing 35 x \varnothing 60 x \varnothing 20 x 6	

Accessories Haas grinding wheel adapter HSK-E50 // Shaft \varnothing 20 mm // Ring set \varnothing 50 mm

Order No.	Name	
350050010	Universal assembly device \varnothing 50	
350040010	*Clamping nut wrench PC27 for \varnothing 20	
350040011	*Clamping nut wrench PC27 for \varnothing 20	
350020021	*Balancing weight pair for clamping nut \varnothing 50 // 100gmm	

Order No.	Name	
350011020	Spacer ring \varnothing 50 x \varnothing 20 x 20	
350011010	Spacer ring \varnothing 50 x \varnothing 20 x 10	
350011004	Spacer ring \varnothing 50 x \varnothing 20 x 4	
350030010	Lock washer \varnothing 50 x \varnothing 20 x 2	
350020060	Clamping nut \varnothing 50 x 6 x M20 x 1 PC27	
350020020	*Clamping nut with balancing option \varnothing 50 x 8,5 M20 x 1,0 PC27	
350015003	Support washer \varnothing 50 x \varnothing 75 x \varnothing 20 x 6	

For Haas tool grinding machines

GWA HSK-E50 and HSK-E80

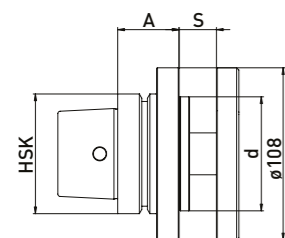
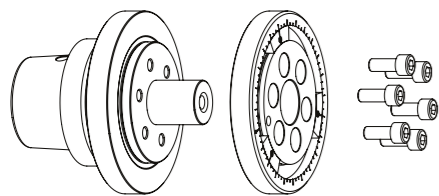

Delivered equipped:
Clamping flange with balancing weights 3pc.
and clamping screws 6pc.

Order No.	HSK	d	A	S
300093011	HSK-E50	51	42	8-25
300093111	HSK-E50	76,2	42	8-25
300094011	HSK-E80	51	42	8-25
300094111	HSK-E80	76,2	42	8-25
300094211	HSK-E80	51	55	25-40

Accessories Haas grinding wheel adapter HSK-E50 and HSK-E80

Order No.	Name
250001059	Balancing weight $\phi 100 \times \phi 80 \times 7$

For Hawema tool grinding machines with ring set $\phi 35$ mm

GWA HSK50 // $\phi 20$ mm // RS $\phi 35$ mm

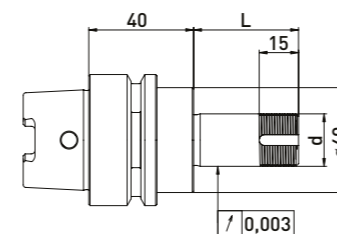
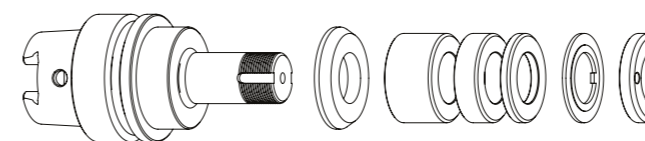

Delivered equipped:
Reducing washer, ring set $\phi 35$ mm, lock washer and clamping nut

Order No.	HSK	d	L	Ring set $\phi 35$ mm		
				B20	B10	B4
300012512	HSK50	20	40	-	1	3
300012522	HSK50	20	60	1	1	3
300012532	HSK50	20	75	1	2	4
300012542	HSK50	20	85	2	1	4
300012552	HSK50	20	100	2	3	3

Accessories Hawema grinding wheel adapter HSK50 // $\phi 20$ mm // Ring set $\phi 35$ mm

Order No.	Name
350050010	Universal assembly device $\phi 50$
350040010	Clamping nut wrench PC27 for $\phi 20$
350040011	Clamping nut wrench PC27 for $\phi 20$
350040040	*Clamping nut wrench PC29 for $\phi 20$ for clamping nut with blancing option
350040041	*Clamping nut wrench PC29 for $\phi 20$
350020081	*Balancing weight pair for clamping nut $\phi 35 // 40$ gmm

GWA HSK50 // $\phi 20$ mm // without RS

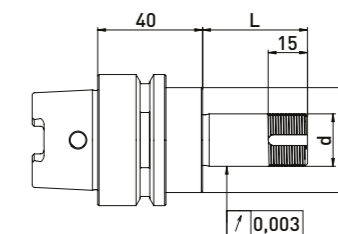
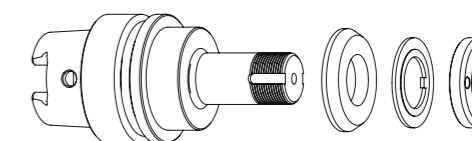

Delivered equipped:
Reducing washer, lock washer and clamping nut

Order No.	HSK	d	L
300012511	HSK50	20	40
300012521	HSK50	20	60
300012531	HSK50	20	75
300012541	HSK50	20	85
300012551	HSK50	20	100

Order No.	Name
350012020	Spacer ring $\phi 35 \times \phi 20 \times 20$
350012010	Spacer ring $\phi 35 \times \phi 20 \times 10$
350012004	Spacer ring $\phi 35 \times \phi 20 \times 4$
350015006	Reducing washer $\phi 40 \times \phi 35 \times \phi 20 \times 6$
350030020	Lock washer $\phi 35 \times \phi 20 \times 2$
350020030	Clamping nut $\phi 35 \times 6$ M20 x 1 PC27
350020080	*Clamping nut with balancing option $\phi 35 \times \phi 40 \times 8 \times$ M20 x 1 PC29
350015005	Support washer $\phi 35 \times \phi 60 \times \phi 20 \times 6$

Hawema HSK50 // Shaft $\varnothing 20$ mm // RS $\varnothing 50$ mm

For Hawema tool grinding machines with ring set $\varnothing 50$ mm

GWA HSK50 // $\varnothing 20$ mm // RS $\varnothing 50$ mm

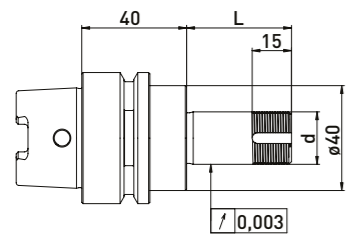
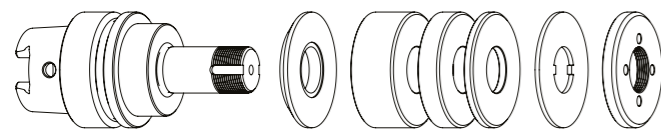

Delivered equipped:

Reducing washer, ring set $\varnothing 50$ mm, lock washer and clamping nut

Order No.	HSK	d	L	Ring set $\varnothing 50$ mm		
				B20	B10	B4
300012012	HSK50	20	40	-	1	3
300012022	HSK50	20	60	1	1	3
300012032	HSK50	20	75	1	2	4
300012042	HSK50	20	85	2	1	4
300012052	HSK50	20	100	2	3	3

GWA HSK50 // $\varnothing 20$ mm // without RS

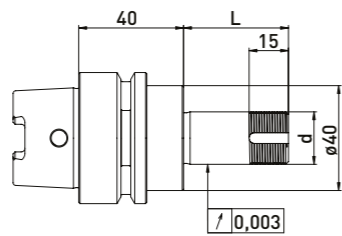
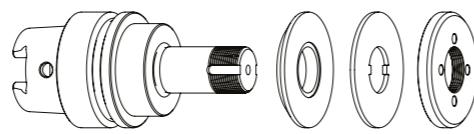

Delivered equipped:

Reducing washer, lock washer and clamping nut

Order No.	HSK	d	L
300012011	HSK50	20	40
300012021	HSK50	20	60
300012031	HSK50	20	75
300012041	HSK50	20	85
300012051	HSK50	20	100

Accessories Hawema grinding wheel adapter HSK50 // $\varnothing 20$ mm // Ring set $\varnothing 50$ mm

Order No.	Name
350050010	Universal assembly device $\varnothing 50$
350040010	*Clamping nut wrench PC27 for $\varnothing 20$
350040011	*Clamping nut wrench PC27 for $\varnothing 20$
350020021	*Balancing weight pair for clamping nut $\varnothing 50$ // 100gmm

Order No.	Name
350011020	Spacer ring $\varnothing 50 \times \varnothing 20 \times 20$
350011010	Spacer ring $\varnothing 50 \times \varnothing 20 \times 10$
350011004	Spacer ring $\varnothing 50 \times \varnothing 20 \times 4$
350015002	Reducing washer $\varnothing 40 \times \varnothing 50 \times \varnothing 20 \times 6$
350030010	Lock washer $\varnothing 50 \times \varnothing 20 \times 2$
350020060	Clamping nut $\varnothing 50 \times 6 \times M20 \times 1$ PC27
350020020	*Clamping nut with balancing option $\varnothing 50 \times 8,5 \times M20 \times 1,0$ PC27
350015003	Support washer $\varnothing 50 \times \varnothing 75 \times \varnothing 20 \times 6$

Reinecker HSK50 // Shaft $\varnothing 20$ mm // RS $\varnothing 35$ mm

For Reinecker tool grinding machines with ring set $\varnothing 35$ mm with driver groove

SSA HSK50 // $\varnothing 20$ mm // RS $\varnothing 35$ mm

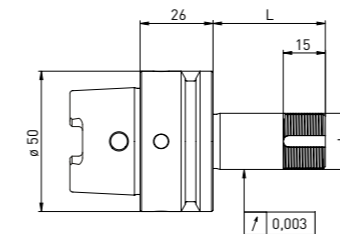
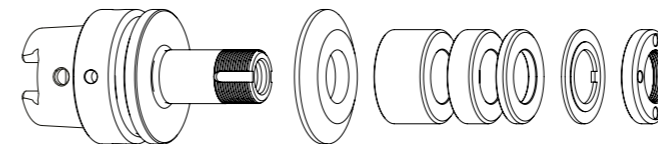

Delivered equipped:

Reducing washer, ring set $\varnothing 35$ mm, lock washer and clamping nut

Order No.	HSK	d	L	Ring set $\varnothing 35$ mm		
				B20	B10	B4
300072512	HSK50	20	40	-	1	3
300072522	HSK50	20	60	1	1	3
300072532	HSK50	20	85	2	1	4
300072542	HSK50	20	110	3	2	3
300072552	HSK50	20	25	-	-	2
300072562	HSK50	20	50	-	2	3
300072572	HSK50	20	75	2	1	2

SSA HSK50 // $\varnothing 20$ mm // without RS

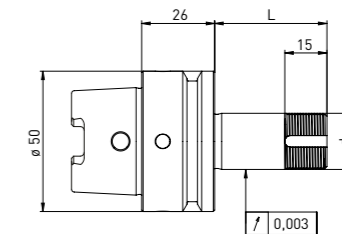
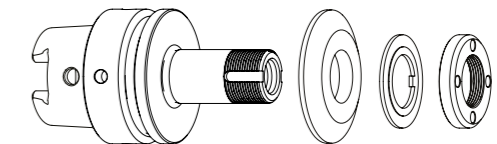

Delivered equipped:

Reducing washer, lock washer and clamping nut

Order No.	HSK	d	L
300072511	HSK50	20	40
300072521	HSK50	20	60
300072531	HSK50	20	85
300072541	HSK50	20	110
300072551	HSK50	20	25
300072561	HSK50	20	50
300072571	HSK50	20	75

Accessories Reinecker grinding wheel adapter SSA HSK50 // $\varnothing 20$ mm // Ring set $\varnothing 35$ mm

Order No.	Name
350050010	Universal assembly device $\varnothing 50$
350040010	Clamping nut wrench PC27 for $\varnothing 20$
350040011	Clamping nut wrench PC27 for $\varnothing 20$
350040040	*Clamping nut wrench PC29 for $\varnothing 20$ for clamping nut with blancing option
350040041	*Clamping nut wrench PC29 for $\varnothing 20$
350020081	*Balancing weight pair for clamping nut $\varnothing 35$ // 40gmm

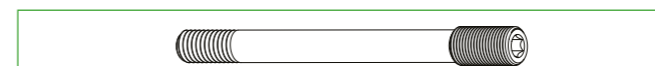

Order No.	Name
250000253	Clamping screw Reinecker L40 - $\varnothing 12 \times 116$
250000254	Clamping screw Reinecker L60 - $\varnothing 12 \times 136$
250000255	Clamping screw Reinecker L85 - $\varnothing 12 \times 161$
250000256	Clamping screw Reinecker L110 - $\varnothing 12 \times 186$

Order No.	Name
350012020	Spacer ring $\varnothing 35 \times \varnothing 20 \times 20$
350012010	Spacer ring $\varnothing 35 \times \varnothing 20 \times 10$
350012004	Spacer ring $\varnothing 35 \times \varnothing 20 \times 4$
350015001	Reducing washer $\varnothing 50 \times \varnothing 35 \times \varnothing 20 \times 6$
350030020	Lock washer $\varnothing 35 \times \varnothing 20 \times 2$
350020030	Clamping nut $\varnothing 35 \times 6 \times M20 \times 1$ PC27
350020080	*Clamping nut with balancing option $\varnothing 35 \times \varnothing 40 \times 8 \times M20 \times 1$ PC29
350015005	Support washer $\varnothing 35 \times \varnothing 60 \times \varnothing 20 \times 6$

*related items

Reinecker HSK50 // Shaft \varnothing 20 mm // RS \varnothing 35 mm

For Reinecker tool grinding machines with ring set \varnothing 35 mm
without driver groove

GWA HSK50 // \varnothing 20 mm // RS \varnothing 35 mm

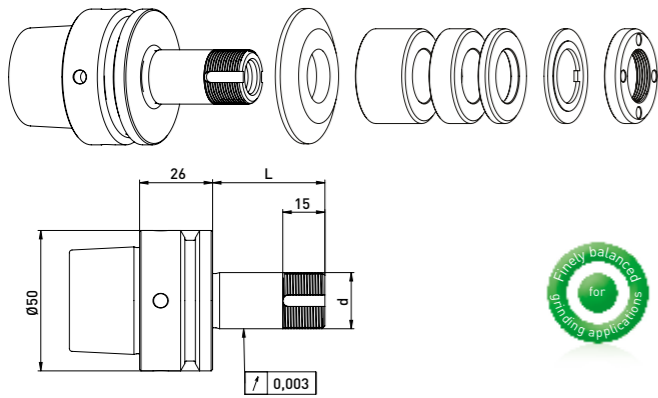

Delivered equipped:

Reducing washer, ring set \varnothing 35 mm, lock washer and clamping nut

Order No.	HSK	d	L	Ring set \varnothing 35 mm		
				B20	B10	B4
300073512	HSK50	20	40	-	1	3
300073522	HSK50	20	60	1	1	3
300073532	HSK50	20	85	2	1	4
300073542	HSK50	20	110	3	2	3
300073552	HSK50	20	25	-	-	2
300073562	HSK50	20	50	-	2	3
300073572	HSK50	20	75	2	1	2

GWA HSK50 // \varnothing 20 mm // without RS

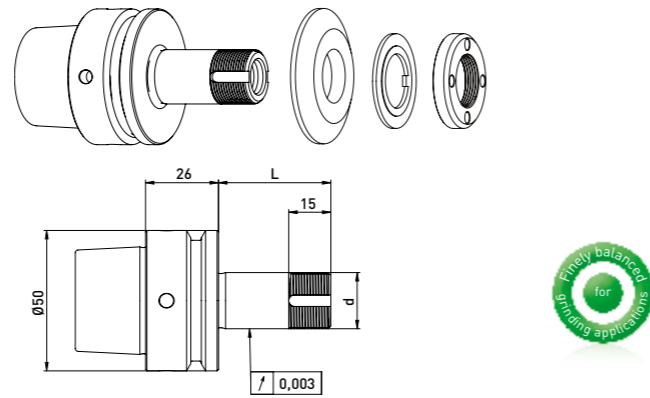

Delivered equipped:

Reducing washer, lock washer and clamping nut

Order No.	HSK	d	L
300073511	HSK50	20	40
300073521	HSK50	20	60
300073531	HSK50	20	85
300073541	HSK50	20	110
300073551	HSK50	20	25
300073561	HSK50	20	50
300073571	HSK50	20	75

Accessories Reinecker grinding wheel adapter HSK50 // \varnothing 20 mm // Ring set \varnothing 35 mm

Order No.	Name	
350050010	Universal assembly device \varnothing 50	
350040010	Clamping nut wrench PC27 for \varnothing 20	
350040011	Clamping nut wrench PC27 for \varnothing 20	
350040040	*Clamping nut wrench PC29 for \varnothing 20 for clamping nut with blancing option	
350040041	*Clamping nut wrench PC29 for \varnothing 20	
350020081	*Balancing weight pair for clamping nut \varnothing 35 // 40gmm	

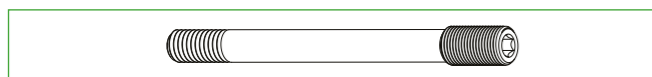

Order No.	Name
250000253	Clamping screw Reinecker L40 - \varnothing 12 x 116
250000254	Clamping screw Reinecker L60 - \varnothing 12 x 136
250000255	Clamping screw Reinecker L85 - \varnothing 12 x 161
250000256	Clamping screw Reinecker L110 - \varnothing 12 x 186

Order No.	Name	
350012020	Spacer ring \varnothing 35 x \varnothing 20 x 20	
350012010	Spacer ring \varnothing 35 x \varnothing 20 x 10	
350012004	Spacer ring \varnothing 35 x \varnothing 20 x 4	
350015001	Reducing washer \varnothing 50 x \varnothing 35 x \varnothing 20 x 6	
350030020	Lock washer \varnothing 35 x \varnothing 20 x 2	
350020030	Clamping nut \varnothing 35 x 6 M20 x 1 PC27	
350020080	*Clamping nut with balancing option \varnothing 35 x \varnothing 40 x 8 x M20 x 1 PC29	
350015005	Support washer \varnothing 35 x \varnothing 60 x \varnothing 20 x 6	

Reinecker HSK50 // Shaft \varnothing 20 mm // RS \varnothing 50 mm

For Reinecker tool grinding machines with ring set \varnothing 50 mm
with driver groove

SSA HSK50 // \varnothing 20 mm // RS \varnothing 50 mm

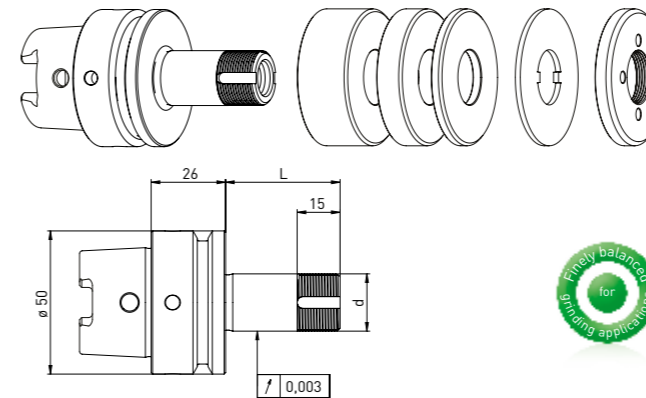

Delivered equipped:

Ring set \varnothing 50 mm, lock washer and clamping nut

Order No.	HSK	d	L	Ring set \varnothing 50mm		
				B20	B10	B4
300072012	HSK50	20	40	-	1	4
300072022	HSK50	20	60	1	1	4
300072032	HSK50	20	85	2	2	3
300072042	HSK50	20	110	3	2	4
300072052	HSK50	20	25	-	-	3
300072062	HSK50	20	50	1	1	2
300072072	HSK50	20	75	2	1	3

SSA HSK50 // \varnothing 20 mm // without RS

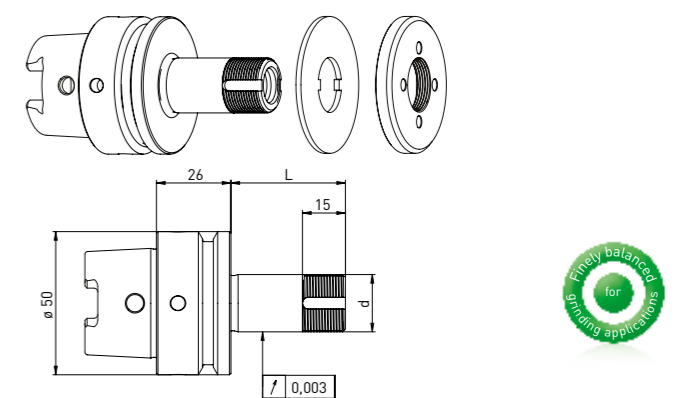

Delivered equipped:

Lock washer and clamping nut

Order No.	HSK	d	L
300072011	HSK50	20	40
300072021	HSK50	20	60
300072031	HSK50	20	85
300072041	HSK50	20	110
300072051	HSK50	20	25
300072061	HSK50	20	50
300072071	HSK50	20	75

Accessories Reinecker grinding wheel adapter SSA HSK50 // \varnothing 20 mm // Ring set \varnothing 50 mm

Order No.	Name	
350050010	Universal assembly device \varnothing 50	
350040010	*Clamping nut wrench PC27 for \varnothing 20	
350040011	*Clamping nut wrench PC27 for \varnothing 20	
350020021	*Balancing weight pair for clamping nut \varnothing 50 // 100gmm	

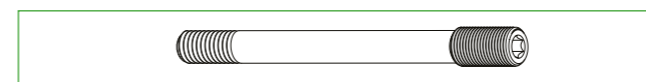

Order No.	Name
250000253	Clamping screw Reinecker L40 - \varnothing 12 x 116
250000254	Clamping screw Reinecker L60 - \varnothing 12 x 136
250000255	Clamping screw Reinecker L85 - \varnothing 12 x 161
250000256	Clamping screw Reinecker L110 - \varnothing 12 x 186

Order No.	Name	
350011020	Spacer ring \varnothing 50 x \varnothing 20 x 20	
350011010	Spacer ring \varnothing 50 x \varnothing 20 x 10	
350011004	Spacer ring \varnothing 50 x \varnothing 20 x 4	
350015003	Support washer \varnothing 50 x \varnothing 75 x \varnothing 20 x 6	
350030010	Lock washer \varnothing 50 x \varnothing 20 x 2	
350020060	Clamping nut \varnothing 50 x 6 x M20 x 1 PC27	
350020020	*Clamping nut with balancing option \varnothing 50 x 8,5 M20 x 1,0 PC27	

Reinecker HSK50 // Shaft $\varnothing 20$ mm // RS $\varnothing 50$ mm

For Reinecker tool grinding machines with ring set $\varnothing 50$ mm
without driver groove

GWA HSK50 // $\varnothing 20$ mm // RS $\varnothing 50$ mm

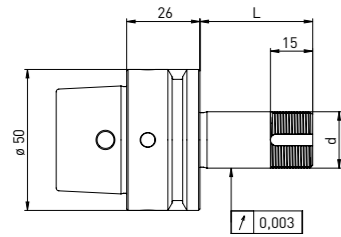
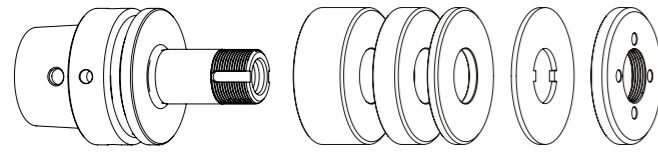

Delivered equipped:
Ring set $\varnothing 50$ mm, lock washer and clamping nut

GWA HSK50 // $\varnothing 20$ mm // without RS

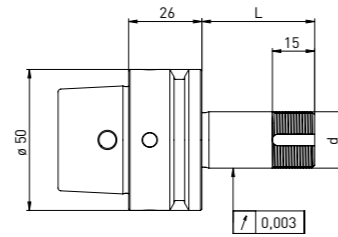
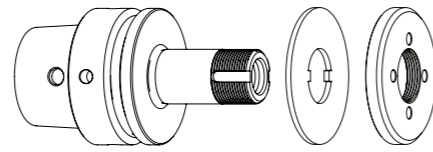

Delivered equipped:
Lock washer and clamping nut

Ring set $\varnothing 50$ mm

Order No.	HSK	d	L	B20	B10	B4
300073012	HSK50	20	40	-	1	4
300073022	HSK50	20	60	1	1	4
300073032	HSK50	20	85	2	2	3
300073042	HSK50	20	110	3	2	4
300073052	HSK50	20	25	-	-	3
300073062	HSK50	20	50	1	1	2
300073072	HSK50	20	75	2	1	3

Order No.	HSK	d	L
300073011	HSK50	20	40
300073021	HSK50	20	60
300073031	HSK50	20	85
300073041	HSK50	20	110
300073051	HSK50	20	25
300073061	HSK50	20	50
300073071	HSK50	20	75

Accessories Reinecker grinding wheel adapter HSK50 // $\varnothing 20$ mm // Ring set $\varnothing 50$ mm

Order No.	Name	
350050010	Universal assembly device $\varnothing 50$	
350040010	*Clamping nut wrench PC27 for $\varnothing 20$	
350040011	*Clamping nut wrench PC27 for $\varnothing 20$	
350020021	*Balancing weight pair for clamping nut $\varnothing 50$ // 100gmm	

Order No.	Name	
350011020	Spacer ring $\varnothing 50 \times \varnothing 20 \times 20$	
350011010	Spacer ring $\varnothing 50 \times \varnothing 20 \times 10$	
350011004	Spacer ring $\varnothing 50 \times \varnothing 20 \times 4$	
350015003	Support washer $\varnothing 50 \times \varnothing 75 \times \varnothing 20 \times 6$	
350030010	Lock washer $\varnothing 50 \times \varnothing 20 \times 2$	
350020060	Clamping nut $\varnothing 50 \times 6 \times M20 \times 1$ PC27	
350020020	*Clamping nut with balancing option $\varnothing 50 \times 8,5$ M20 x 1,0 PC27	

Order No.	Name	
250000253	Clamping screw Reinecker L40 - $\varnothing 12 \times 116$	
250000254	Clamping screw Reinecker L60 - $\varnothing 12 \times 136$	
250000255	Clamping screw Reinecker L85 - $\varnothing 12 \times 161$	
250000256	Clamping screw Reinecker L110 - $\varnothing 12 \times 186$	

Due to constant improvements to and further developments of our designs, the information and illustrations in this brochure are non-binding. The specifications and mounted lengths provided by the machine manufacturer must be observed. All specifications are in mm.

Reinecker HSK50 // Shaft $\varnothing 31,75$ mm (1 1/4) // RS $\varnothing 60$ mm

For Reinecker tool grinding machines with ring set $\varnothing 60$ mm
without driver groove

GWA HSK50 // $\varnothing 31,75$ mm (1 1/4) // RS $\varnothing 60$ mm

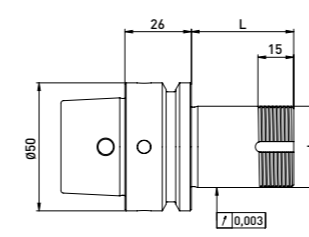
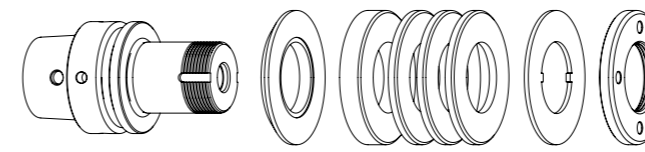

Delivered equipped:
Ring set $\varnothing 60$ mm, lock washer and clamping nut

GWA HSK50 // $\varnothing 31,75$ mm (1 1/4) // ohne Ringsatz

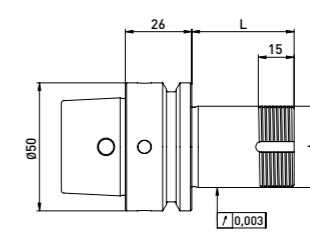
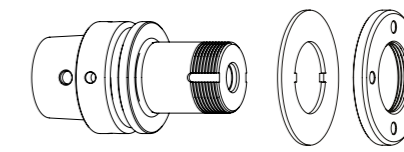

Delivered equipped:
Lock washer and clamping nut

Ring set $\varnothing 60$ mm

Order No.	HSK	d	L	B20	B10	B4
300072112	HSK50	31,75	40	-	2	3
300072122	HSK50	31,75	60	1	1	3
300072132	HSK50	31,75	85	2	2	4
300072142	HSK50	31,75	100	3	2	3

Order No.	HSK	d	L
300072111	HSK50	31,75	40
300072121	HSK50	31,75	60
300072131	HSK50	31,75	85
300072141	HSK50	31,75	100

Accessories Reinecker grinding wheel adapter HSK50 // $\varnothing 31,75$ mm (1 1/4) // Ring set $\varnothing 60$ mm

Order No.	Name	
350050010	Universal assembly device $\varnothing 50$	
350040030	*Clamping nut wrench TK39 for clamping nut with blancing option	
350040020	Clamping nut wrench PC45 for $\varnothing 32$	
350020023	*Balancing weight pair for clamping nut $\varnothing 60$ // 200gmm	

Order No.	Name	
350011420	Spacer ring $\varnothing 60 \times \varnothing 31,75 \times 20$	
350011410	Spacer ring $\varnothing 60 \times \varnothing 31,75 \times 10$	
350011404	Spacer ring $\varnothing 60 \times \varnothing 31,75 \times 4$	
350015009	Support washer	
350030060	Lock washer $\varnothing 60 \times \varnothing 32 \times 1,8$	
350020066	Clamping nut $\varnothing 60 \times 6 \times M32 \times 1,5$ PC45	
350020022	*Clamping nut with balancing option $\varnothing 60 \times 9$ M32 x 1,5 PC39	

Order No.	Name	
250000253	Clamping screw Reinecker L40 - $\varnothing 12 \times 116$	
250000254	Clamping screw Reinecker L60 - $\varnothing 12 \times 136$	
250000255	Clamping screw Reinecker L85 - $\varnothing 12 \times 161$	
250000256	Clamping screw Reinecker L110 - $\varnothing 12 \times 186$	

*related items

Rollomatic $\varnothing 25$ mm // Shaft $\varnothing 20$ mm // RS $\varnothing 50$ mm

For Rollomatic tool grinding machines with ring set $\varnothing 50$ mm



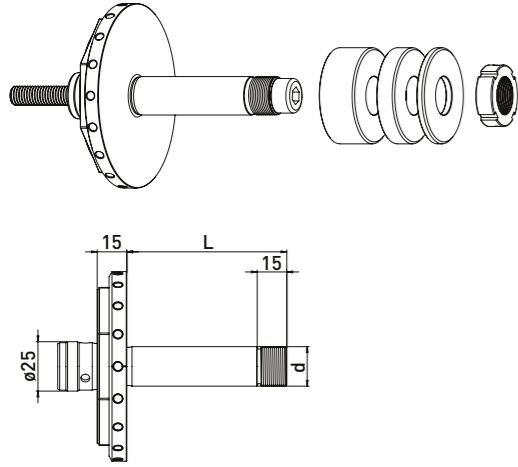



GWA $\varnothing 25$ mm // $\varnothing 20$ mm // RS $\varnothing 50$ mm



Delivered equipped:
Ring set $\varnothing 50$ mm, M10 clamping screw and clamping nut

Order No.	d	L	Ring set $\varnothing 50$ mm		
			B20	B10	B4
300150412	20	50	-	2	4
300150422	20	81	1	3	4

Accessories Rollomatic grinding wheel adapter $\varnothing 25$ mm // Shaft $\varnothing 20$ mm // RS $\varnothing 50$ mm

Order No.	Name	Order No.	Name
350040051	Hook wrench 30 - 32 mm 	350011520	Spacer ring Rollomatic $\varnothing 50 \times \varnothing 20 \times 20$ 
		350011510	Spacer ring Rollomatic $\varnothing 50 \times \varnothing 20 \times 10$ 
		350011504	Spacer ring Rollomatic $\varnothing 50 \times \varnothing 20 \times 4$ 
		350020120	Clamping nut MRR20x1 M20 x 1 - $\varnothing 32 \times 10$ 
		350015003	Support washer $\varnothing 50 \times \varnothing 75 \times \varnothing 20 \times 6$ 

Rollomatic $\varnothing 25$ mm // Shaft $\varnothing 31,75$ mm (1 1/4)

For Rollomatic tool grinding machines

GWA $\varnothing 25$ mm // $\varnothing 31,75$ mm (1 1/4)

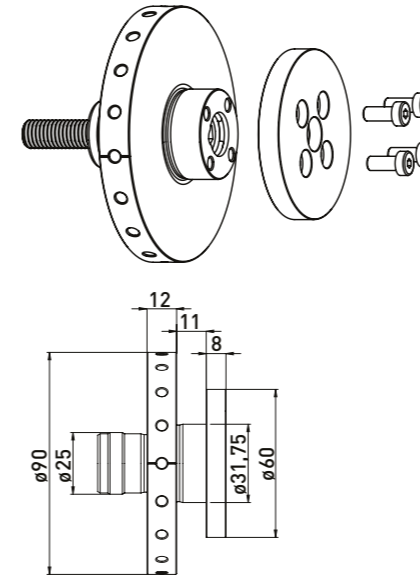

Delivered equipped:
Clamping flange, 4pc. M5x12 cylinder screws and M10 clamping screw

Order No.	Name
300150510	Grinding wheel adapter Rollomatic $\varnothing 31,75 \times 11$

Rollomatic $\varnothing 25$ mm // Shaft $\varnothing 31,75$ mm ($1\frac{1}{4}$) // RS $\varnothing 60$ mm

For Rollomatic tool grinding machines with ring set $\varnothing 60$ mm

GWA $\varnothing 25$ mm // $\varnothing 31,75$ mm ($1\frac{1}{4}$) // RS $\varnothing 60$ mm

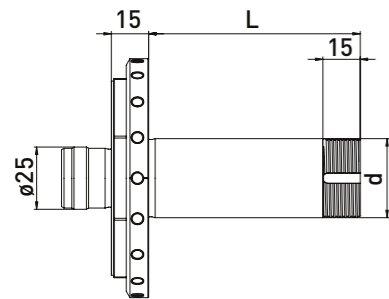
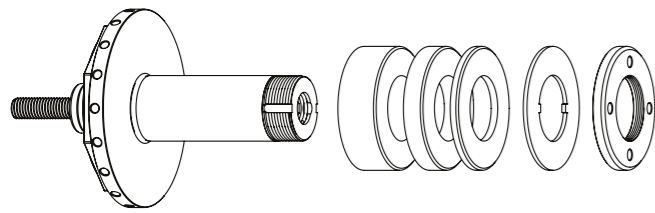







Delivered equipped:

Ring set $\varnothing 60$ mm, M10 clamping screw, lock washer and clamping nut

Order No.	d	L	Ring set $\varnothing 60$ mm		
			B 20	B 10	B 4
300150212	31,75	50	-	2	4
300150222	31,75	85	2	2	3
300150232	31,75	115	3	3	3

Accessories Rollomatic grinding wheel adapter $\varnothing 25$ mm // $\varnothing 31,75$ mm ($1\frac{1}{4}$) // RS $\varnothing 60$ mm

Order No.	Name	Order No.	Name
350040020	Clamping nut wrench PC45 for $\varnothing 32$ 	350011620	Spacer ring Rollomatic $\varnothing 60 \times \varnothing 31,75 \times 20$ 
		350011610	Spacer ring Rollomatic $\varnothing 60 \times \varnothing 31,75 \times 10$ 
		350011604	Spacer ring Rollomatic $\varnothing 60 \times \varnothing 31,75 \times 4$ 
		350030060	Lock washer $\varnothing 60 \times \varnothing 32 \times 1,8$ 
		350020066	Clamping nut $\varnothing 60 \times 6 \times M32 \times 1,5$ PC45 

Rollomatic $\varnothing 25$ mm // Shaft $\varnothing 32$ // RS $\varnothing 60$ mm

For Rollomatic tool grinding machines with ring set $\varnothing 60$ mm

GWA $\varnothing 25$ mm // $\varnothing 32$ mm // RS $\varnothing 60$ mm

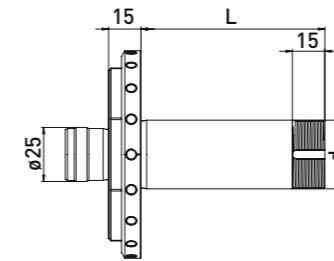
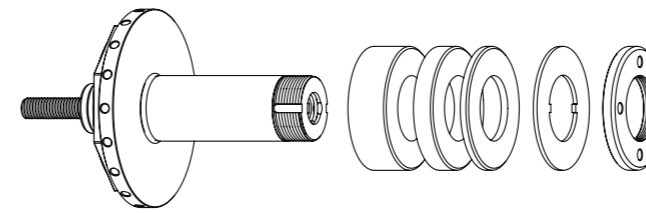







Delivered equipped:

Ring set $\varnothing 60$ mm, M10 clamping screw lock washer and clamping nut

Order No.	d	L	Ring set $\varnothing 60$ mm		
			B 20	B 10	B 4
300150312	32	50	-	2	4
300150322	32	85	2	2	3
300150332	32	115	3	3	3

Accessories Rollomatic grinding wheel adapter $\varnothing 25$ mm // Shaft $\varnothing 32$ mm // RS $\varnothing 60$ mm

Order No.	Name	Order No.	Name
350040020	Clamping nut wrench PC45 for $\varnothing 32$ 	350011320	Spacer ring $\varnothing 60 \times \varnothing 32 \times 20$ 
		350011310	Spacer ring $\varnothing 60 \times \varnothing 32 \times 10$ 
		350011304	Spacer ring $\varnothing 60 \times \varnothing 32 \times 4$ 
		350030060	Lock washer $\varnothing 60 \times \varnothing 32 \times 1,8$ 
		350020066	Clamping nut $\varnothing 60 \times 6 \times M32 \times 1,5$ PC45 

Rollomatic $\varnothing 25$ mm // stepped Shaft $\varnothing 25$, $\varnothing 35$, $\varnothing 50$ mm

For Rollomatic tool grinding machines

GWA $\varnothing 25$ mm // stepped Shaft

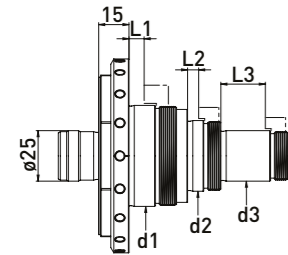
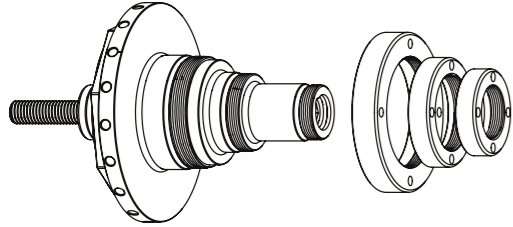

Delivered equipped:

per 1 piece clamping nut $\varnothing 38$ (350020110), $\varnothing 48$ (350020111), $\varnothing 70$ (350020113) and M10 clamping screw

Order No.	L1	L2	L3	d1	d2	d3
300150111	11,5	5,5	5,5	50	35	25
300150121	7,5	5,5	22	50	35	25

Delivered equipped:

per 1 piece clamping nut $\varnothing 38$ (350020110), $\varnothing 58$ (350020112) and M10 clamping screw

Order No.	L1	L2	L3	d1	d2	d3
300150131	11,5	5,5		40	25	

Delivered equipped:

per 1 piece clamping nut $\varnothing 38$ (350020110), $\varnothing 70$ (350020113) and M10 clamping screw

Order No.	L1	L2	L3	d1	d2	d3
300150141	11,5	5,5		50	25	

Accessories Rollomatic grinding wheel adapter $\varnothing 25$ mm // stepped Shaft $\varnothing 25$, $\varnothing 35$, $\varnothing 50$ mm

Order No.	Name	for d
350020110	Clamping nut Rollomatic $\varnothing 38$ x 10 M24 x 1	25
350020111	Clamping nut Rollomatic $\varnothing 48$ x 10 M34 x 1	35
350020112	Clamping nut Rollomatic $\varnothing 58$ x 11 M39 x 1	40
350020113	Clamping nut Rollomatic $\varnothing 70$ x 12 M49 x 1	50

Order No.	Name
350016001	Spacer ring $\varnothing 38$ x $\varnothing 25$ x 5
350016002	Spacer ring $\varnothing 58$ x $\varnothing 40$ x 5
350016003	Spacer ring $\varnothing 70$ x $\varnothing 50$ x 5
350016005	Spacer ring $\varnothing 48$ x $\varnothing 35$ x 5

Rollomatic HSK50 // stepped Shaft $\varnothing 25$, $\varnothing 35$, $\varnothing 50$ mm

For Rollomatic tool grinding machines

GWA HSK50 // stepped Shaft

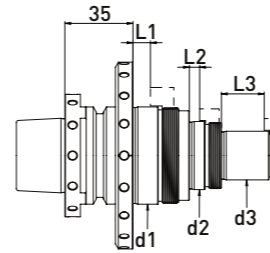
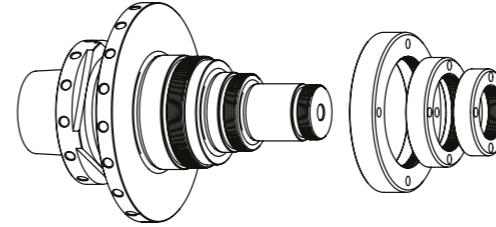

Delivered equipped:

per 1 piece clamping nut $\varnothing 38$ (350020110), $\varnothing 48$ (350020111), $\varnothing 70$ (350020113) and M10 clamping screw

Order No.	L1	L2	L3	d1	d2	d3
300150921	7,5	5,5	22	50	35	25

Accessories Rollomatic grinding wheel adapter $\varnothing 25$ mm // stepped Shaft $\varnothing 25$, $\varnothing 35$, $\varnothing 50$ mm

Order No.	Name	for d
350020110	Clamping nut Rollomatic $\varnothing 38$ x 10 M24 x 1	25
350020111	Clamping nut Rollomatic $\varnothing 48$ x 10 M34 x 1	35
350020112	Clamping nut Rollomatic $\varnothing 58$ x 11 M39 x 1	40
350020113	Clamping nut Rollomatic $\varnothing 70$ x 12 M49 x 1	50

Order No.	Name
350016001	Spacer ring $\varnothing 38$ x $\varnothing 25$ x 5
350016002	Spacer ring $\varnothing 58$ x $\varnothing 40$ x 5
350016003	Spacer ring $\varnothing 70$ x $\varnothing 50$ x 5
350016005	Spacer ring $\varnothing 48$ x $\varnothing 35$ x 5

Rollomatic HSK-E50 // Shaft $\varnothing 20$ mm // RS $\varnothing 50$ mm

For Rollomatic tool grinding machines with ring set $\varnothing 50$ mm

GWA HSK-E50 // $\varnothing 20$ mm // RS $\varnothing 50$ mm

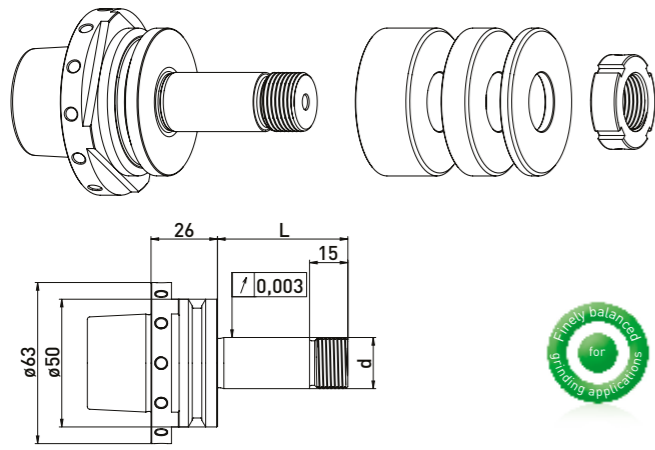

GWA HSK-E50 // $\varnothing 20$ mm // without RS

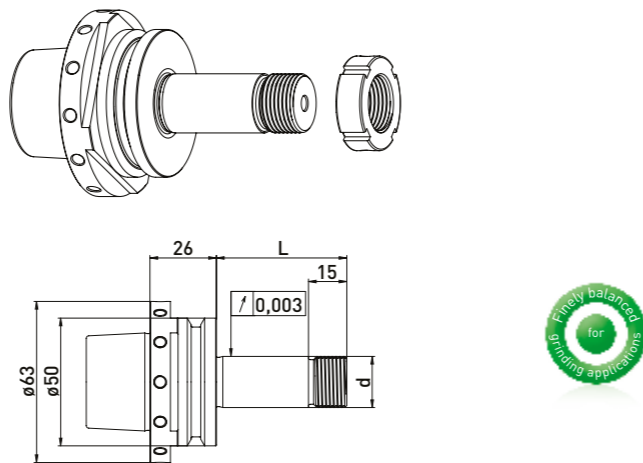







Delivered equipped:
Ring set $\varnothing 50$ mm and clamping nut

Order No.	HSK	d	L	Ring set $\varnothing 50$ mm		
				B20	B10	B4
300150612	HSK-E50	20	51	1	1	2
300150632	HSK-E50	20	81	2	2	2

Delivered equipped:
Clamping nut

Order No.	HSK	d	L
300150611	HSK-E50	20	51
300150631	HSK-E50	20	81

Accessories Rollomatic grinding wheel adapter GWA HSK-E50 // Shaft $\varnothing 20$ mm // RS $\varnothing 50$ mm

Order No.	Name	Order No.	Name
350040051	Hook wrench 30 - 32 mm 	350011520	Spacer ring Rollomatic $\varnothing 50 \times \varnothing 20 \times 20$ 
		350011510	Spacer ring Rollomatic $\varnothing 50 \times \varnothing 20 \times 10$ 
		350011504	Spacer ring Rollomatic $\varnothing 50 \times \varnothing 20 \times 4$ 
		350020121	Clamping nut MRR20 x 1,5 M20 x 1,5 $\varnothing 32 \times 10$ 
		350015003	Support washer $\varnothing 50 \times \varnothing 75 \times \varnothing 20 \times 6$ 

Rollomatic HSK50E // Shaft $\varnothing 20$ mm // RS $\varnothing 50$ mm

For Rollomatic tool grinding machines with ring set $\varnothing 50$ mm
with cross groove

SSA HSK50E // $\varnothing 20$ mm // RS $\varnothing 50$ mm

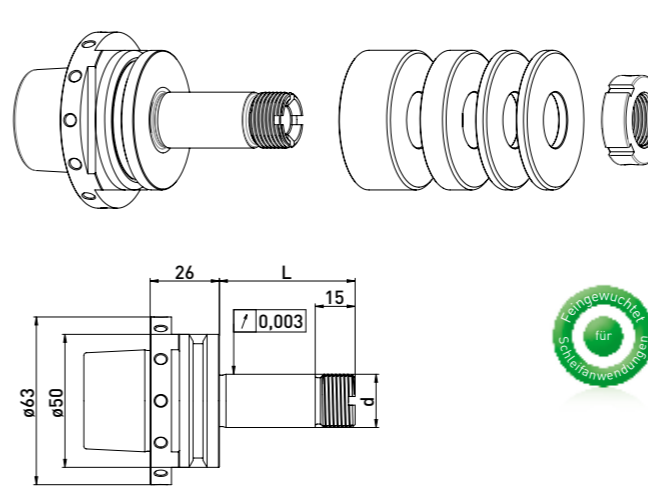

Delivered equipped:
Ring set $\varnothing 50$ mm and clamping nut

Order No.	HSK	d	L	Ring set $\varnothing 50$ mm		
				B20	B10	B4
300150652	HSK50E	20	51	1	1	2
300150662	HSK50E	20	81	2	2	2



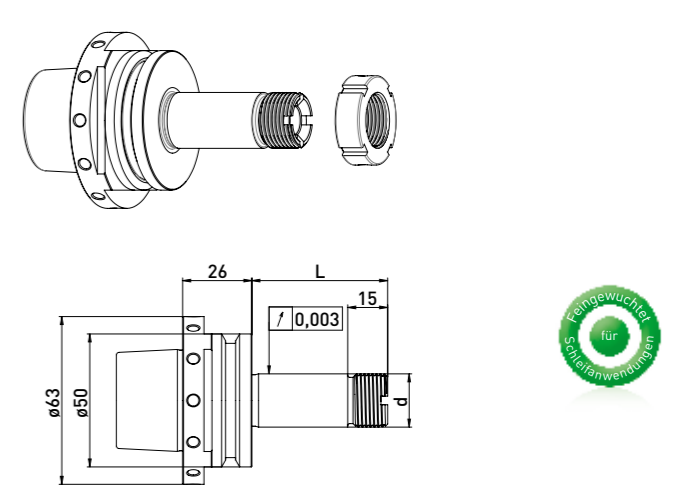



SSA HSK50E // $\varnothing 20$ mm // ohne RS



Delivered equipped:
Clamping nut

Order No.	HSK	d	L
300150651	HSK50E	20	51
300150661	HSK50E	20	81

Accessories Rollomatic grinding wheel adapter GWA HSK-E50 // Shaft $\varnothing 20$ mm // RS $\varnothing 50$ mm

Order No.	Name	Order No.	Name
350040051	Hook wrench 30 - 32 mm 	350011520	Spacer ring Rollomatic $\varnothing 50 \times \varnothing 20 \times 20$ 
		350011510	Spacer ring Rollomatic $\varnothing 50 \times \varnothing 20 \times 10$ 
		350011504	Spacer ring Rollomatic $\varnothing 50 \times \varnothing 20 \times 4$ 
		350020121	Clamping nut MRR20 x 1,5 M20 x 1,5 $\varnothing 32 \times 10$ 
		350015003	Support washer $\varnothing 50 \times \varnothing 75 \times \varnothing 20 \times 6$ 

Rollomatic HSK-E50 // Shaft $\varnothing 31,75$ mm (1¼) // RS $\varnothing 60$ mm

For Rollomatic tool grinding machines with ring set $\varnothing 60$ mm

GWA HSK-E50 // $\varnothing 31,75$ mm (1¼) // RS $\varnothing 60$ mm

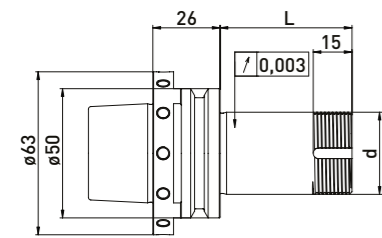
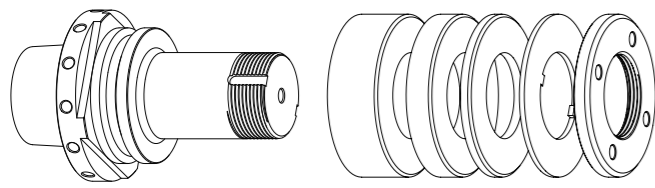

Delivered equipped:
Ring set $\varnothing 60$ mm and clamping nut

GWA HSK-E50 // $\varnothing 31,75$ mm (1¼) // without RS

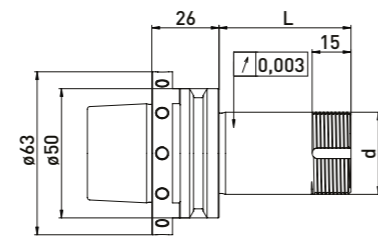
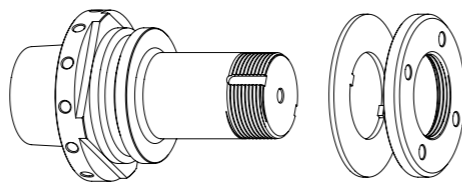

Delivered equipped:
Clamping nut

Ring set $\varnothing 60$ mm

Order No.	HSK	d	L	B20	B10	B4
300150712	HSK-50E	31,75	51	-	1	3
300150732	HSK-50E	31,75	81	1	1	3

Order No.	HSK	d	L
300150711	HSK-50E	31,75	51
300150731	HSK-50E	31,75	81

Accessories Rollomatic grinding wheel adapter HSK-E50 // Shaft $\varnothing 31,75$ mm (1¼) // Ring set $\varnothing 60$ mm

Order No.	Name	Order No.	Name
350040030	*Clamping nut wrench PC39 for clamping nut with blancing option	350011420	Spacer ring $\varnothing 60$ x $\varnothing 31,75$ x 20
350040020	Clamping nut wrench PC45 for $\varnothing 32$	350011410	Spacer ring $\varnothing 60$ x $\varnothing 31,75$ x 10
350020023	*Balancing weight pair for clamping nut $\varnothing 60$ // 200gmm	350011404	Spacer ring $\varnothing 60$ x $\varnothing 31,75$ x 4
		350030060	Lock washer $\varnothing 60$ x $\varnothing 32$ x 1,8
		350020066	Clamping nut $\varnothing 60$ x 6 x M32 x 1,5 PC45
		350020022	*Clamping nut with balancing option $\varnothing 60$ x 9 M32 x 1,5 PC39

Saacke HSK50 // Shaft $\varnothing 20$ mm // RS $\varnothing 35$ mm

For Saacke tool grinding machines with ring set $\varnothing 35$ mm

GWA HSK50 // $\varnothing 20$ mm // RS $\varnothing 35$ mm

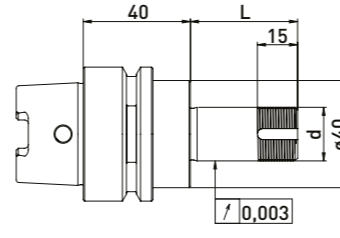
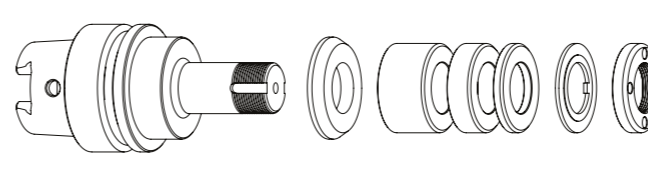

Delivered equipped:
Reducing washer, ring set $\varnothing 35$ mm, lock washer and clamping nut

GWA HSK50 // $\varnothing 20$ mm // without RS

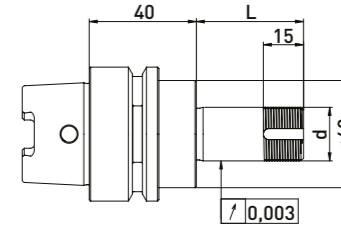
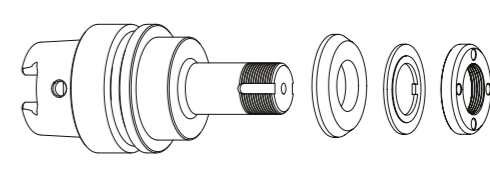

Delivered equipped:
Reducing washer, lock washer and clamping nut

Ring set $\varnothing 35$ mm

Order No.	HSK	d	L	B20	B10	B4
300012512	HSK50	20	40	-	1	3
300012522	HSK50	20	60	1	1	3
300012532	HSK50	20	75	1	2	4
300012542	HSK50	20	85	2	1	4
300012552	HSK50	20	100	2	3	3

Order No.	HSK	d	L
300012511	HSK50	20	40
300012521	HSK50	20	60
300012531	HSK50	20	75
300012541	HSK50	20	85
300012551	HSK50	20	100

Accessories Saacke grinding wheel adapter HSK50 // Shaft $\varnothing 20$ mm // Ring set $\varnothing 35$ mm

Order No.	Name	Order No.	Name
350050010	Universal assembly device $\varnothing 50$	350012020	Spacer ring $\varnothing 35$ x $\varnothing 20$ x 20
350040010	Clamping nut wrench PC27 for $\varnothing 20$	350012010	Spacer ring $\varnothing 35$ x $\varnothing 20$ x 10
350040011	Clamping nut wrench PC27 for $\varnothing 20$	350012004	Spacer ring $\varnothing 35$ x $\varnothing 20$ x 4
350040040	*Clamping nut wrench PC29 for $\varnothing 20$ for clamping nut with Balancing option	350015006	Reducing washer $\varnothing 40$ x $\varnothing 35$ x $\varnothing 20$ x 6
350040041	*Clamping nut wrench PC29 for $\varnothing 20$	350030020	Lock washer $\varnothing 35$ x $\varnothing 20$ x 2
350020081	*Balancing weight pair for clamping nut $\varnothing 35$ // 40gmm	350020030	Clamping nut $\varnothing 35$ x 6 M20 x 1 PC27
		350020080	*Clamping nut with balancing option $\varnothing 35$ x $\varnothing 40$ x 8 x M20 x 1 PC29
		350015005	Support washer $\varnothing 35$ x $\varnothing 60$ x $\varnothing 20$ x 6

Saacke HSK50 // Shaft $\varnothing 20$ mm // RS $\varnothing 50$ mm

For Saacke tool grinding machines with ring set $\varnothing 50$ mm

GWA HSK50 // $\varnothing 20$ mm // RS $\varnothing 50$ mm

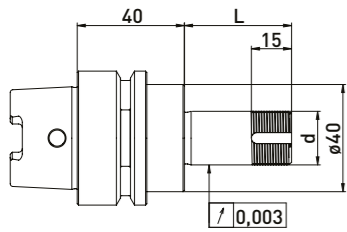
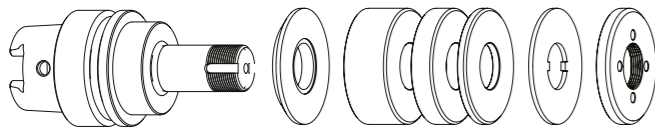

Delivered equipped:

Reducing washer, ring set $\varnothing 50$ mm, lock washer and clamping nut

Ring set $\varnothing 50$ mm

Order No.	HSK	d	L	B20	B10	B4
300012012	HSK50	20	40	-	1	3
300012022	HSK50	20	60	1	1	3
300012032	HSK50	20	75	1	2	4
300012042	HSK50	20	85	2	1	4
300012052	HSK50	20	100	2	3	3

GWA HSK50 // $\varnothing 20$ mm // without RS

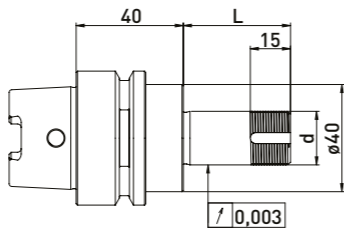
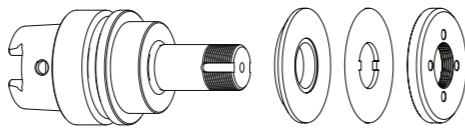

Delivered equipped:

Reducing washer, lock washer and clamping nut

Order No.	HSK	d	L
300012011	HSK50	20	40
300012021	HSK50	20	60
300012031	HSK50	20	75
300012041	HSK50	20	85
300012051	HSK50	20	100

Accessories Saacke grinding wheel adapter HSK50 // Shaft $\varnothing 20$ mm // Ring set $\varnothing 50$ mm

Order No.	Name	Order No.	Name
350050010	Universal assembly device $\varnothing 50$	350011020	Spacer ring $\varnothing 50 \times \varnothing 20 \times 20$
350040010	*Clamping nut wrench PC27 for $\varnothing 20$	350011010	Spacer ring $\varnothing 50 \times \varnothing 20 \times 10$
350040011	*Clamping nut wrench PC27 for $\varnothing 20$	350011004	Spacer ring $\varnothing 50 \times \varnothing 20 \times 4$
350020021	*Balancing weight pair for clamping nut $\varnothing 50 // 100$ gmm	350030010	Lock washer $\varnothing 50 \times \varnothing 20 \times 2$
		350020060	Clamping nut $\varnothing 50 \times 6 \times M20 \times 1$ PC27
		350020020	*Clamping nut with balancing option $\varnothing 50 \times 8,5$ M20 $\times 1,0$ PC27
		350015002	Reducing washer $\varnothing 40 \times \varnothing 50 \times \varnothing 20 \times 6$

Saacke HSK50 // Shaft $\varnothing 31,75$ mm // RS $\varnothing 60$ mm

For Saacke tool grinding machines with ring set $\varnothing 60$ mm

GWA HSK50 // $\varnothing 31,75$ mm // RS $\varnothing 60$ mm

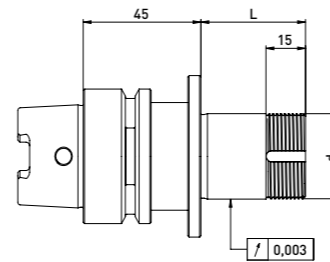
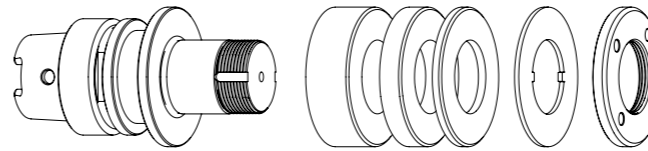

Delivered equipped:

Reducing washer, ring set $\varnothing 60$ mm, lock washer and clamping nut

Ring set $\varnothing 60$ mm

Order No.	HSK	d	L	B20	B10	B4
300012112	HSK50	31,75	40	-	1	3
300012122	HSK50	31,75	60	1	1	3
300012132	HSK50	31,75	75	1	2	4
300012142	HSK50	31,75	85	2	1	4
300012152	HSK50	31,75	100	2	3	3

GWA HSK50 // $\varnothing 31,75$ mm // without RS

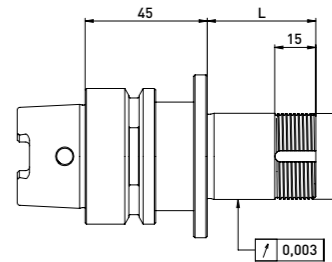
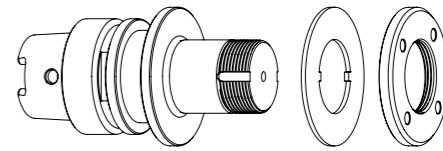

Delivered equipped:

Reducing washer, lock washer and clamping nut

Order No.	HSK	d	L
300012111	HSK50	31,75	40
300012121	HSK50	31,75	60
300012131	HSK50	31,75	75
300012141	HSK50	31,75	85
300012151	HSK50	31,75	100

Accessories Saacke grinding wheel adapter HSK50 // Shaft $\varnothing 31,75$ mm // Ring set $\varnothing 60$ mm

Order No.	Name	Order No.	Name
350050010	Universal assembly device $\varnothing 50$	350011420	Spacer ring $\varnothing 60 \times \varnothing 31,75 \times 20$
350040030	*Clamping nut wrench PC39 for clamping nut with balancing option	350011410	Spacer ring $\varnothing 60 \times \varnothing 31,75 \times 10$
350040020	Clamping nut wrench PC45 for $\varnothing 32$	350011404	Spacer ring $\varnothing 60 \times \varnothing 31,75 \times 4$
350020023	*Balancing weight pair for clamping nut $\varnothing 60 // 200$ gmm	350015009	Support washer
		350030060	Lock washer $\varnothing 60 \times \varnothing 32 \times 1,8$
		350020066	Clamping nut $\varnothing 60 \times 6 \times M32 \times 1,5$ PC45
		350020022	*Clamping nut with balancing option $\varnothing 60 \times 9$ M32 $\times 1,5$ PC39

Saacke short taper // Shaft $\varnothing 20$ mm // RS $\varnothing 50$ mm

For Saacke tool grinding machines with ring set $\varnothing 50$ mm

GWA short taper // $\varnothing 20$ mm // RS $\varnothing 50$ mm

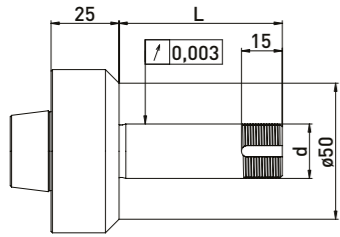
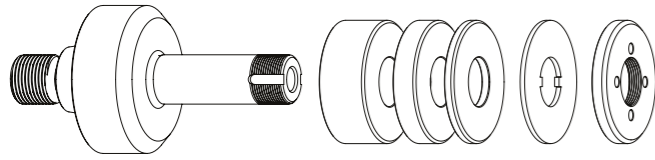

Delivered equipped:

Ring set $\varnothing 50$ mm, lock washer, tightening screw and clamping nut

Order No.	taper	d	L	Ring set $\varnothing 50$ mm		
				B20	B10	B4
300014012	Saacke	20	40	-	1	4
300014022	Saacke	20	60	1	1	4
300014042	Saacke	20	100	2	3	4

Accessories Saacke grinding wheel adapter short taper // Shaft $\varnothing 20$ mm // Ring set $\varnothing 50$ mm

Order No.	Name	Image
350040010	*Clamping nut wrench PC27 for $\varnothing 20$	
350040011	*Clamping nut wrench PC27 for $\varnothing 20$	
350020021	*Balancing weight pair for clamping nut $\varnothing 50$ // 100gmm	
250000107	Tightening screw Saacke $\varnothing 20$ x 49	

Order No.	Name	Image
350011020	Spacer ring $\varnothing 50$ x $\varnothing 20$ x 20	
350011010	Spacer ring $\varnothing 50$ x $\varnothing 20$ x 10	
350011004	Spacer ring $\varnothing 50$ x $\varnothing 20$ x 4	
350030010	Lock washer $\varnothing 50$ x $\varnothing 20$ x 2	
350020060	Clamping nut $\varnothing 50$ x 6 x M20 x 1 PC27	
350020020	*Clamping nut with balancing option $\varnothing 50$ x 8,5 M20 x 1,0 PC27	
350015003	Support washer $\varnothing 50$ x $\varnothing 75$ x $\varnothing 20$ x 6	

Schneeberger HSK32 // Shaft $\varnothing 20$ mm // RS $\varnothing 35$ mm

For Schneeberger tool grinding machines with ring set $\varnothing 35$ mm

GWA HSK32 // $\varnothing 20$ mm // RS $\varnothing 35$ mm

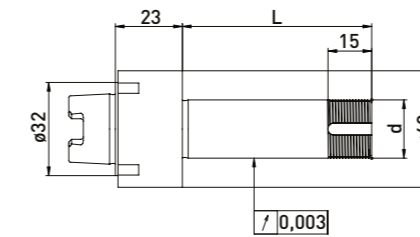
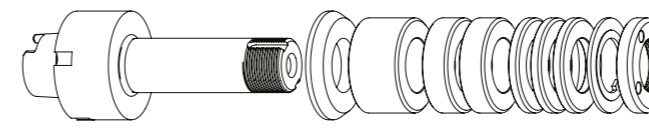

Delivered equipped:

Reducing washer, ring set $\varnothing 35$ mm, lock washer and clamping nut

Order No.	HSK	d	L	Ring set $\varnothing 35$ mm		
				B20	B10	B4
300045512	HSK32	20	65	1	2	3
300045522	HSK32	20	85	1	3	5
300045532	HSK32	20	110	2	3	7

GWA HSK32 // $\varnothing 20$ mm // without RS

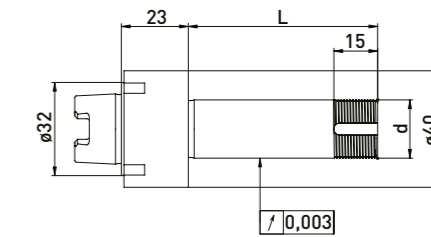
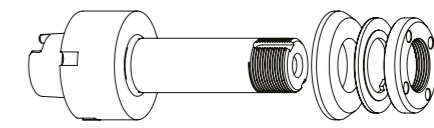

Delivered equipped:

Reducing washer, lock washer and clamping nut

Order No.	HSK	d	L
300045511	HSK32	20	65
300045521	HSK32	20	85
300045531	HSK32	20	110

Accessories Schneeberger grinding wheel adapter short taper HSK32 // Shaft $\varnothing 20$ mm // Ring set $\varnothing 35$ mm

Order No.	Name	Image
350050010	Universal assembly device $\varnothing 50$	
350050030	Assembly device Schneeberger For assembly on the workbench, in a vice or in the universal assembly device	
350040010	Clamping nut wrench PC27 for $\varnothing 20$	
350040011	Clamping nut wrench PC27 for $\varnothing 20$	
350040040	*Clamping nut wrench PC29 for $\varnothing 20$ for clamping nut with balancing option	
350040041	*Clamping nut wrench PC29 for $\varnothing 20$	
350020081	*Balancing weight pair for clamping nut $\varnothing 35$ // 40gmm	
213011050	Clamping screw Schneeberger M8/M8 x 62	

Order No.	Name	Image
350012020	Spacer ring $\varnothing 35$ x $\varnothing 20$ x 20	
350012010	Spacer ring $\varnothing 35$ x $\varnothing 20$ x 10	
350012004	Spacer ring $\varnothing 35$ x $\varnothing 20$ x 4	
350015001	Reducing washer $\varnothing 50$ x $\varnothing 35$ x $\varnothing 20$ x 6	
350030020	Lock washer $\varnothing 35$ x $\varnothing 20$ x 2	
350020030	Clamping nut $\varnothing 35$ x 6 M20 x 1 PC27	
350020080	*Clamping nut with balancing option $\varnothing 35$ x $\varnothing 40$ x 8 x M20 x 1 PC29	

Schneeberger HSK50 // Shaft \varnothing 10 mm // RS 20 mm

For Schneeberger tool grinding machines with ring set \varnothing 20 mm

GWA HSK50 // Shaft \varnothing 10 mm // RS \varnothing 20 mm

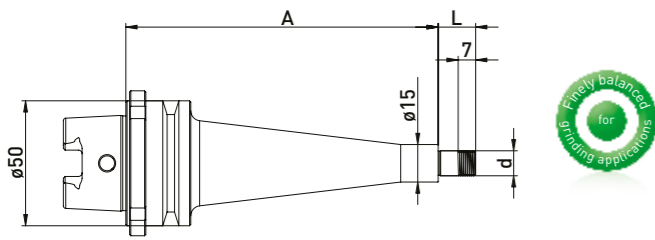
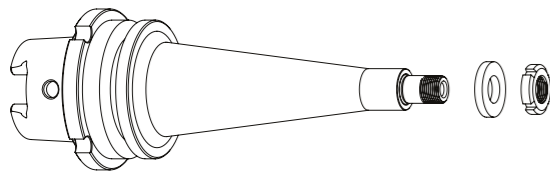



Delivered equipped:
Ring set \varnothing 20 mm and clamping nut

Ring set \varnothing 20 mm					
Order No.	HSK	d	L	A	B3
300044012	HSK50	10	15	60	3
300044022	HSK50	10	15	125	3

Accessories Schneeberger grinding wheel adapter HSK50 // Shaft \varnothing 10 mm // Ring set \varnothing 20 mm

Order No.	Name
350040050	Hook wrench 16 - 20 mm 

Order No.	Name
350016004	Spacer ring \varnothing 20 x \varnothing 10 x 3 
350020114	Clamping nut \varnothing 18 x 4 M10 x 0,75 

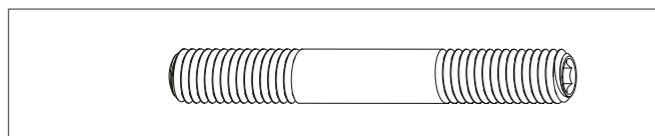

Order No.	Name
213011050	Clamping screw Schneeberger M8/M8 x 62

Schneeberger HSK50 // Shaft \varnothing 20 mm // RS \varnothing 35 mm

For Schneeberger tool grinding machines with ring set \varnothing 35 mm

GWA HSK50 // \varnothing 20 mm // RS \varnothing 35 mm

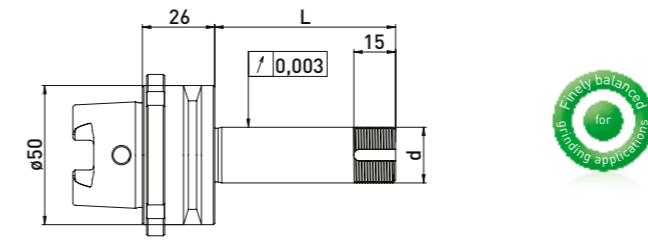
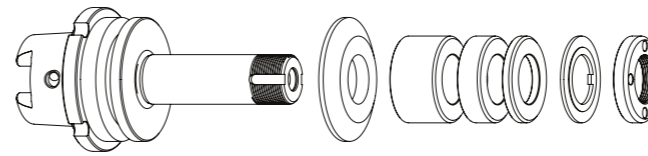

Delivered equipped:
Reducing washer, ring set \varnothing 35 mm, lock washer and clamping nut

Ring set \varnothing 35 mm						
Order No.	HSK	d	L	B20	B10	B4
300042512	HSK50	20	45	-	1	4
300042522	HSK50	20	65	1	1	4
300042532	HSK50	20	85	2	1	4
300042542	HSK50	20	110	3	2	2



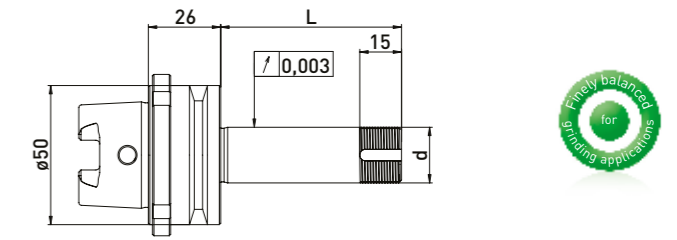
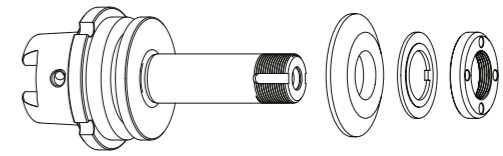





GWA HSK50 // \varnothing 20 mm // without RS









Delivered equipped:
Reducing washer, lock washer and clamping nut

Order No.	HSK	d	L
300042511	HSK50	20	45
300042521	HSK50	20	65
300042531	HSK50	20	85
300042541	HSK50	20	110

Accessories Schneeberger grinding wheel adapter HSK50 // Shaft \varnothing 20 mm // Ring set \varnothing 35 mm

Order No.	Name
350050010	Universal assembly device \varnothing 50 
350050030	Assembly device Schneeberger For assembly on the workbench, in a vice or in the puniversal assembly device 
350040010	Clamping nut wrench PC27 for \varnothing 20 
350040011	Clamping nut wrench PC27 for \varnothing 20 
350040040	*Clamping nut wrench PC29 for \varnothing 20 for clamping nut with blancing option 
350040041	*Clamping nut wrench PC29 for \varnothing 20 
350020081	*Balancing weight pair for clamping nut \varnothing 35 // 40gmm 
213011050	Clamping screw Schneeberger M8/M8 x 62 

Order No.	Name
350012020	Spacer ring \varnothing 35 x \varnothing 20 x 20 
350012010	Spacer ring \varnothing 35 x \varnothing 20 x 10 
350012004	Spacer ring \varnothing 35 x \varnothing 20 x 4 
350015001	Reducing washer \varnothing 50 x \varnothing 35 x \varnothing 20 x 6 
350030020	Lock washer \varnothing 35 x \varnothing 20 x 2 
350020030	Clamping nut \varnothing 35 x 6 M20 x 1 PC27 
350020080	*Clamping nut with balancing option \varnothing 35 x \varnothing 40 x 8 x M20 x 1 PC29 

*related items

Schneeberger HSK50 // Shaft $\varnothing 20$ mm // RS $\varnothing 50$ mm

For Schneeberger tool grinding machines with ring set $\varnothing 50$ mm

GWA HSK50 // $\varnothing 20$ mm // RS $\varnothing 50$ mm

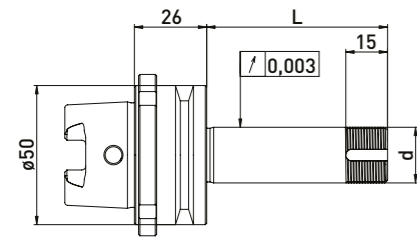
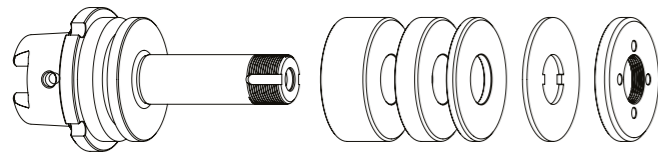

Delivered equipped:
Ring set $\varnothing 50$ mm, lock washer and clamping nut

GWA HSK50 // $\varnothing 20$ mm // without RS

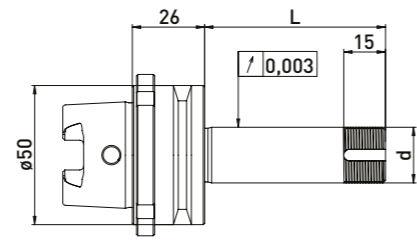
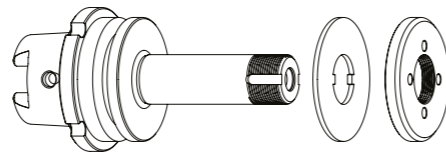

Delivered equipped:
Lock washer and clamping nut

Ring set $\varnothing 50$ mm

Order No.	HSK	d	L	B20	B10	B4
300042012	HSK50	20	45	-	2	3
300042022	HSK50	20	65	1	2	3
300042032	HSK50	20	85	2	2	3
300042042	HSK50	20	110	3	2	4

Order No.	HSK	d	L
300042011	HSK50	20	45
300042021	HSK50	20	65
300042031	HSK50	20	85
300042041	HSK50	20	110

Accessories Schneeberger grinding wheel adapter HSK50 // Shaft $\varnothing 20$ mm // Ring set $\varnothing 50$ mm

Order No.	Name	
350050010	Universal assembly device $\varnothing 50$	
350050030	Assembly device Schneeberger For assembly on the workbench, in a vice or in the puniversal assembly device	
350040010	*Clamping nut wrench PC27 for $\varnothing 20$	
350040011	*Clamping nut wrench PC27 for $\varnothing 20$	
350020021	*Balancing weight pair for clamping nut $\varnothing 50$ // 100gmm	
213011050	Clamping screw Schneeberger M8/M8 x 62	

Order No.	Name	
350011020	Spacer ring $\varnothing 50$ x $\varnothing 20$ x 20	
350011010	Spacer ring $\varnothing 50$ x $\varnothing 20$ x 10	
350011004	Spacer ring $\varnothing 50$ x $\varnothing 20$ x 4	
350030010	Lock washer $\varnothing 50$ x $\varnothing 20$ x 2	
350020060	Clamping nut $\varnothing 50$ x 6 x M20 x 1 PC27	
350020020	*Clamping nut with balancing option $\varnothing 50$ x 8,5 M20 x 1,0 PC27	

Schneeberger HSK50 NGC // Shaft $\varnothing 20$ mm // RS $\varnothing 35$ mm

For Schneeberger tool grinding machines with ring set $\varnothing 35$ mm

GWA HSK50 NGC // $\varnothing 20$ mm // RS $\varnothing 35$ mm

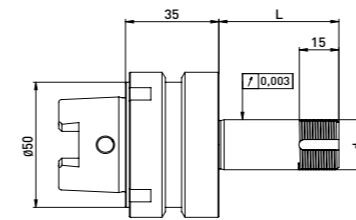
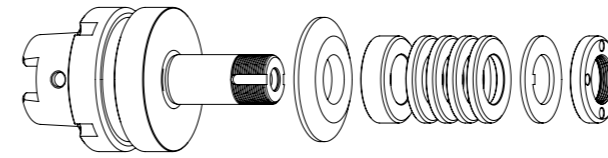

Delivered equipped:
Reducing washer, ring set $\varnothing 35$ mm, lock washer and clamping nut

GWA HSK50 NGC // $\varnothing 20$ mm // without RS

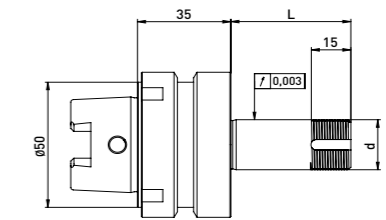
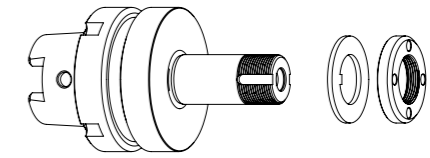

Delivered equipped:
Lock washer and clamping nut

Ringset $\varnothing 35$ mm

Best.-Nr.	HSK	d	L	B20	B10	B4
300046512	HSK50	20	45	-	1	4
300046522	HSK50	20	65	1	1	4
300046532	HSK50	20	85	2	1	4
300046542	HSK50	20	110	3	2	2

Best.-Nr.	HSK	d	L
300046511	HSK50	20	45
300046521	HSK50	20	65
300046531	HSK50	20	85
300046541	HSK50	20	110

Accessories Schneeberger grinding wheel adapter HSK50 NGC // Shaft $\varnothing 20$ mm // Ring set $\varnothing 35$ mm

Order No.	Name	
350050010	Universal assembly device $\varnothing 50$	
350050030	Assembly device Schneeberger For assembly on the workbench, in a vice or in the puniversal assembly device	
350040010	Clamping nut wrench PC27 for $\varnothing 20$	
350040011	Clamping nut wrench PC27 for $\varnothing 20$	
350040040	*Clamping nut wrench PC29 for $\varnothing 20$ for clamping nut with blancing option	
350040041	*Clamping nut wrench PC29 for $\varnothing 20$	
350020081	*Balancing weight pair for clamping nut $\varnothing 35$ // 40gmm	
213011050	Clamping screw Schneeberger M8/M8 x 62	

Order No.	Name	
350012020	Spacer ring $\varnothing 35$ x $\varnothing 20$ x 20	
350012010	Spacer ring $\varnothing 35$ x $\varnothing 20$ x 10	
350012004	Spacer ring $\varnothing 35$ x $\varnothing 20$ x 4	
350015001	Reducing washer $\varnothing 50$ x $\varnothing 35$ x $\varnothing 20$ x 6	
350030020	Lock washer $\varnothing 35$ x $\varnothing 20$ x 2	
350020030	Clamping nut $\varnothing 35$ x 6 M20 x 1 PC27	
350020080	*Clamping nut with balancing option $\varnothing 35$ x $\varnothing 40$ x 8 x M20 x 1 PC29	

Schneeberger HSK50 NGC // Shaft $\varnothing 20$ mm // RS $\varnothing 50$ mm

For Schneeberger tool grinding machines with ring set $\varnothing 50$ mm

GWA HSK50 NGC // $\varnothing 20$ mm // RS $\varnothing 50$ mm

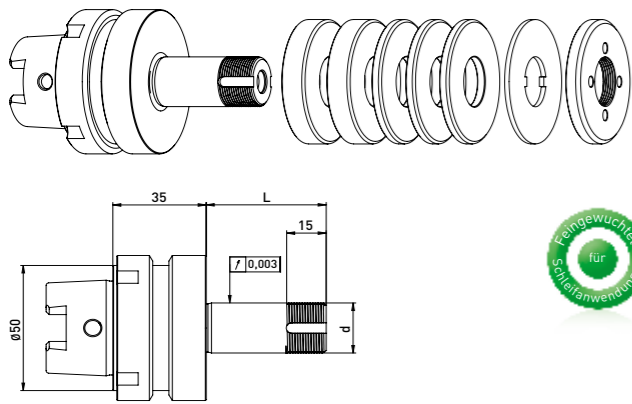

Delivered equipped:
Ring set $\varnothing 50$ mm, lock washer and clamping nut

GWA HSK50 NGC // $\varnothing 20$ mm // without RS

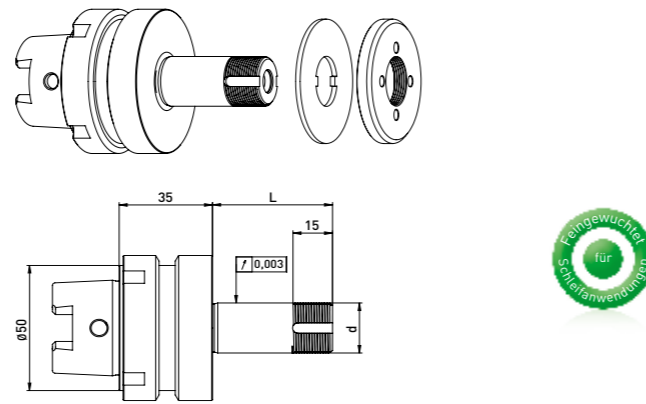

Delivered equipped:
Lock washer and clamping nut

Best.-Nr.	HSK	d	L	Ringsatz $\varnothing 50$ mm		
				B20	B10	B4
300046012	HSK50	20	45	-	2	3
300046022	HSK50	20	65	1	2	3
300046032	HSK50	20	85	2	2	3
300046042	HSK50	20	110	3	2	4

Best.-Nr.	HSK	d	L
300046011	HSK50	20	45
300046021	HSK50	20	65
300046031	HSK50	20	85
300046041	HSK50	20	110

Accessories Schneeberger grinding wheel adapter HSK50 NGC // Shaft $\varnothing 20$ mm // Ring set $\varnothing 50$ mm

Order No.	Name	Order No.	Name
350050010	Universal assembly device $\varnothing 50$	350011020	Spacer ring $\varnothing 50$ x $\varnothing 20$ x 20
350050030	Assembly device Schneeberger For assembly on the workbench, in a vice or in the puniversal assembly device	350011010	Spacer ring $\varnothing 50$ x $\varnothing 20$ x 10
350040010	*Clamping nut wrench PC27 for $\varnothing 20$	350011004	Spacer ring $\varnothing 50$ x $\varnothing 20$ x 4
350040011	*Clamping nut wrench PC27 for $\varnothing 20$	350030010	Lock washer $\varnothing 50$ x $\varnothing 20$ x 2
350020021	*Balancing weight pair for clamping nut $\varnothing 50$ // 100gmm	350020060	Clamping nut $\varnothing 50$ x 6 x M20 x 1 PC27
213011050	Clamping screw Schneeberger M8/M8 x 62	350020020	*Clamping nut with balancing option $\varnothing 50$ x 8,5 M20 x 1,0 PC27

Schneeberger HSK50 // Shaft $\varnothing 20$ mm // RS $\varnothing 50$ mm

For Schneeberger tool grinding machines with ring set $\varnothing 50$ mm

GWA HSK50 // $\varnothing 20$ mm // RS $\varnothing 50$ mm

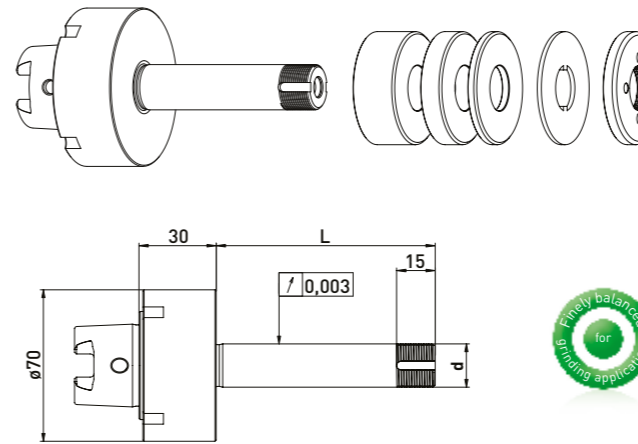

Delivered equipped:
Ring set $\varnothing 50$ mm, lock washer and clamping nut

Order No.	HSK	d	L	Ring set $\varnothing 50$ mm		
				B20	B10	B4
300043012	HSK50	20	45	-	2	3
300043022	HSK50	20	85	2	2	3
300043032	HSK50	20	150	4	4	4

GWA HSK50 // $\varnothing 20$ mm // without RS

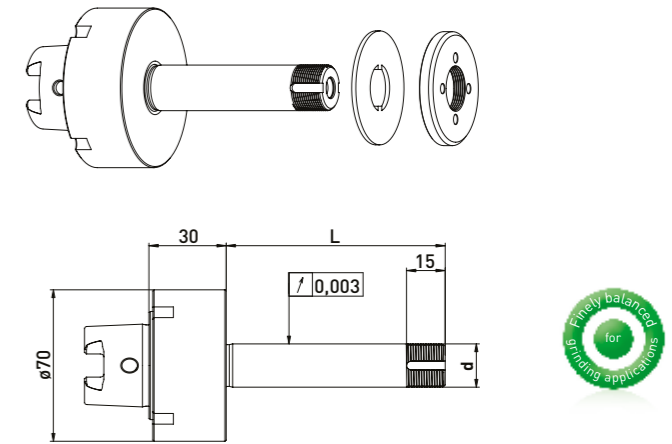

Delivered equipped:
Lock washer and clamping nut

Order No.	HSK	d	L
300043011	HSK50	20	45
300043021	HSK50	20	85
300043031	HSK50	20	150

Accessories Schneeberger grinding wheel adapter HSK50 // Shaft $\varnothing 20$ mm // Ring set $\varnothing 50$ mm

Order No.	Name	Order No.	Name
350050010	Universal assembly device $\varnothing 50$	350011020	Spacer ring $\varnothing 50$ x $\varnothing 20$ x 20
350040010	*Clamping nut wrench PC27 for $\varnothing 20$	350011010	Spacer ring $\varnothing 50$ x $\varnothing 20$ x 10
350040011	*Clamping nut wrench PC27 for $\varnothing 20$	350011004	Spacer ring $\varnothing 50$ x $\varnothing 20$ x 4
350020021	*Balancing weight pair for clamping nut $\varnothing 50$ // 100gmm	350030010	Lock washer $\varnothing 50$ x $\varnothing 20$ x 2
213011050	Clamping screw Schneeberger M8/M8 x 62	350020060	Clamping nut $\varnothing 50$ x 6 x M20 x 1 PC27
		350020020	*Clamping nut with balancing option $\varnothing 50$ x 8,5 M20 x 1,0 PC27

Schütte HSK50 // Shaft $\varnothing 20$ mm // RS $\varnothing 35$ mm

For Schütte tool grinding machines with ring set $\varnothing 35$ mm Series 205

GWA HSK50 // $\varnothing 20$ mm // RS $\varnothing 35$ mm

GWA HSK50 // $\varnothing 20$ mm // without RS

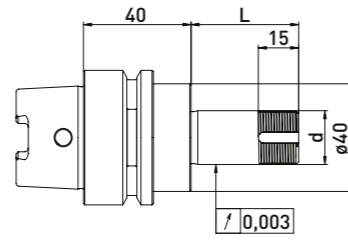
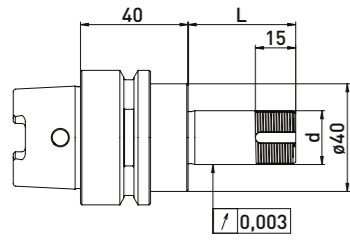
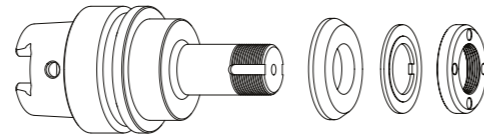
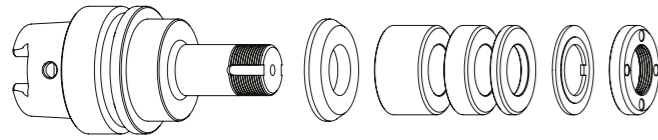

Delivered equipped:
Reducing washer, ring set $\varnothing 35$ mm, lock washer and clamping nut

Delivered equipped:
Reducing washer, lock washer and clamping nut

Order No.	HSK	d	L	Ring set $\varnothing 35$ mm		
				B20	B10	B4
300012512	HSK50	20	40	-	1	3
300012522	HSK50	20	60	1	1	3
300012532	HSK50	20	75	1	2	4
300012542	HSK50	20	85	2	1	4
300012552	HSK50	20	100	2	3	3

Order No.	HSK	d	L
300012511	HSK50	20	40
300012521	HSK50	20	60
300012531	HSK50	20	75
300012541	HSK50	20	85
300012551	HSK50	20	100

Accessories Schütte grinding wheel adapter HSK50 // Shaft $\varnothing 20$ mm // Ring set $\varnothing 35$ mm

Order No.	Name	
350050010	Universal assembly device $\varnothing 50$	
350040010	Clamping nut wrench PC27 for $\varnothing 20$	
350040011	Clamping nut wrench PC27 for $\varnothing 20$	
350040040	*Clamping nut wrench PC29 for $\varnothing 20$ for clamping nut with blancing option	
350040041	*Clamping nut wrench PC29 for $\varnothing 20$	
350020081	*Balancing weight pair for clamping nut $\varnothing 35$ // 40gmm	

Order No.	Name	
350012020	Spacer ring $\varnothing 35$ x $\varnothing 20$ x 20	
350012010	Spacer ring $\varnothing 35$ x $\varnothing 20$ x 10	
350012004	Spacer ring $\varnothing 35$ x $\varnothing 20$ x 4	
350015006	Reducing washer $\varnothing 40$ x $\varnothing 35$ x $\varnothing 20$ x 6	
350030020	Lock washer $\varnothing 35$ x $\varnothing 20$ x 2	
350020030	Clamping nut $\varnothing 35$ x 6 M20 x 1 PC27	
350020080	*Clamping nut with balancing option $\varnothing 35$ x $\varnothing 40$ x 8 x M20 x 1 PC29	
350015005	Support washer $\varnothing 35$ x $\varnothing 60$ x $\varnothing 20$ x 6	

Schütte HSK50 // Shaft $\varnothing 20$ mm // RS $\varnothing 50$ mm

For Schütte tool grinding machines with ring set $\varnothing 50$ mm Series 205

GWA HSK50 // $\varnothing 20$ mm // RS $\varnothing 50$ mm

GWA HSK50 // $\varnothing 20$ mm // without RS

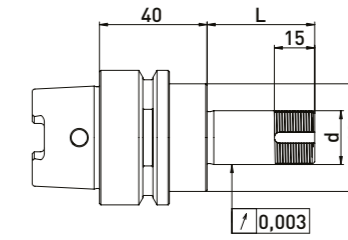
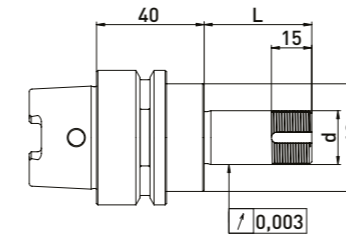
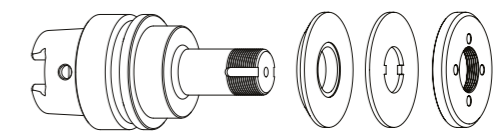
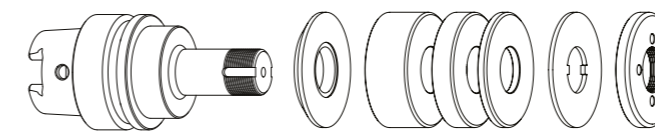

Delivered equipped:
Ring set $\varnothing 50$ mm, lock washer and clamping nut

Delivered equipped:
Lock washer and clamping nut

Order No.	HSK	d	L	Ring set $\varnothing 50$ mm		
				B20	B10	B4
300012012	HSK50	20	40	-	1	3
300012022	HSK50	20	60	1	1	3
300012032	HSK50	20	75	1	2	4
300012042	HSK50	20	85	2	1	4
300012052	HSK50	20	100	2	3	3

Order No.	HSK	d	L
300012011	HSK50	20	40
300012021	HSK50	20	60
300012031	HSK50	20	75
300012041	HSK50	20	85
300012051	HSK50	20	100

Accessories Schütte grinding wheel adapter HSK50 // Shaft $\varnothing 20$ mm // Ring set $\varnothing 50$ mm

Order No.	Name	
350050010	Universal assembly device $\varnothing 50$	
350040010	*Clamping nut wrench PC27 for $\varnothing 20$	
350040011	*Clamping nut wrench PC27 for $\varnothing 20$	
350020021	*Balancing weight pair for clamping nut $\varnothing 50$ // 100gmm	

Order No.	Name	
350011020	Spacer ring $\varnothing 50$ x $\varnothing 20$ x 20	
350011010	Spacer ring $\varnothing 50$ x $\varnothing 20$ x 10	
350011004	Spacer ring $\varnothing 50$ x $\varnothing 20$ x 4	
350030010	Lock washer $\varnothing 50$ x $\varnothing 20$ x 2	
350020060	Clamping nut $\varnothing 50$ x 6 x M20 x 1 PC27	
350020020	*Clamping nut with balancing option $\varnothing 50$ x 8,5 M20 x 1,0 PC27	
350015002	Reducing washer $\varnothing 40$ x $\varnothing 50$ x $\varnothing 20$ x 6	

Schütte HSK-E50 // Shaft $\varnothing 20$ mm // RS $\varnothing 35$ mm

For Schütte tool grinding machines with ring set $\varnothing 35$ mm Series 305

GWA HSK-E50 // $\varnothing 20$ mm // RS $\varnothing 35$ mm

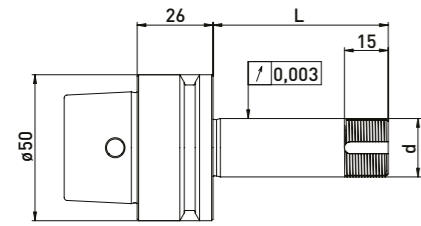
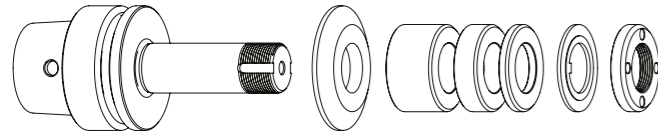

Delivered equipped:
Reducing washer, ring set $\varnothing 35$ mm, lock washer and clamping nut

Ring set $\varnothing 35$ mm

Order No.	HSK	d	L	Ring set $\varnothing 35$ mm		
				B20	B10	B4
300052512	HSK-E50	20	40	-	1	3
300052522	HSK-E50	20	60	1	1	3
300052532	HSK-E50	20	85	2	1	4

GWA HSK-E50 // $\varnothing 20$ mm // without RS

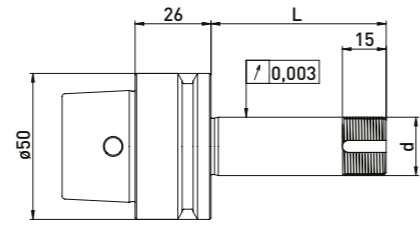
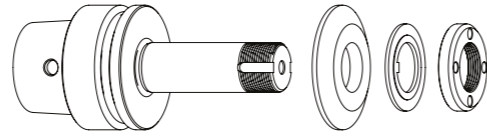

Delivered equipped:
Reducing washer, lock washer and clamping nut

Order No.	HSK	d	L
300052511	HSK-E50	20	40
300052521	HSK-E50	20	60
300052531	HSK-E50	20	85

Schütte HSK-E50 // Shaft $\varnothing 20$ mm // RS $\varnothing 50$ mm

For Schütte tool grinding machines with ring set $\varnothing 50$ mm Series 305

GWA HSK-E50 // $\varnothing 20$ mm // RS $\varnothing 50$ mm

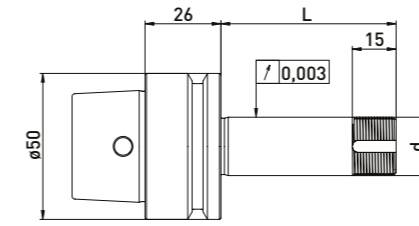
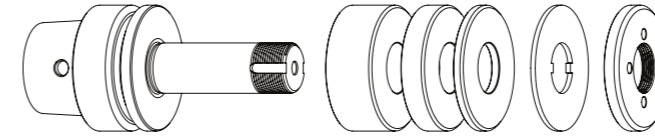

Delivered equipped:
Ring set $\varnothing 50$ mm, lock washer and clamping nut

Ring set $\varnothing 50$ mm

Order No.	HSK	d	L	Ring set $\varnothing 50$ mm		
				B20	B10	B4
300052012	HSK-E50	20	40	-	1	4
300052022	HSK-E50	20	60	1	1	4
300052032	HSK-E50	20	85	2	2	3

GWA HSK-E50 // $\varnothing 20$ mm // without RS

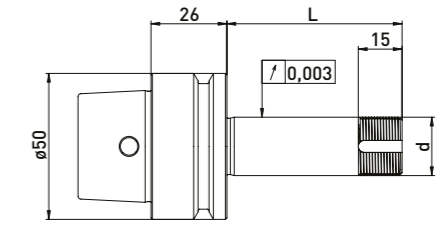
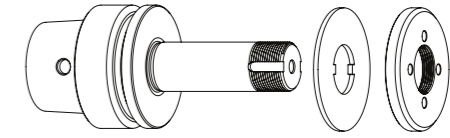

Delivered equipped:
Lock washer and clamping nut

Order No.	HSK	d	L
300052011	HSK-E50	20	40
300052021	HSK-E50	20	60
300052031	HSK-E50	20	85

Accessories Schütte grinding wheel adapter HSK-E50 // Shaft $\varnothing 20$ mm // Ring set $\varnothing 35$ mm

Order No.	Name	
350050010	Universal assembly device $\varnothing 50$	
350040010	Clamping nut wrench PC27 for $\varnothing 20$	
350040011	Clamping nut wrench PC27 for $\varnothing 20$	
350040040	*Clamping nut wrench PC29 for $\varnothing 20$ for clamping nut with blancing option	
350040041	*Clamping nut wrench PC29 for $\varnothing 20$	
350020081	*Balancing weight pair for clamping nut $\varnothing 35$ // 40gmm	

Order No.	Name	
350012020	Spacer ring $\varnothing 35$ x $\varnothing 20$ x 20	
350012010	Spacer ring $\varnothing 35$ x $\varnothing 20$ x 10	
350012004	Spacer ring $\varnothing 35$ x $\varnothing 20$ x 4	
350015001	Reducing washer $\varnothing 50$ x $\varnothing 35$ x $\varnothing 20$ x 6	
350030020	Lock washer $\varnothing 35$ x $\varnothing 20$ x 2	
350020030	Clamping nut $\varnothing 35$ x 6 M20 x 1 PC27	
350020080	*Clamping nut with balancing option $\varnothing 35$ x $\varnothing 40$ x 8 x M20 x 1 PC29	
350015005	Support washer $\varnothing 35$ x $\varnothing 60$ x $\varnothing 20$ x 6	

Accessories Schütte grinding wheel adapter HSK-E50 // Shaft $\varnothing 20$ mm // Ring set $\varnothing 50$ mm

Order No.	Name	
350050010	Universal assembly device $\varnothing 50$	
350040010	*Clamping nut wrench PC27 for $\varnothing 20$	
350040011	*Clamping nut wrench PC27 for $\varnothing 20$	
350020021	*Balancing weight pair for clamping nut $\varnothing 50$ // 100gmm	

Order No.	Name	
350011020	Spacer ring $\varnothing 50$ x $\varnothing 20$ x 20	
350011010	Spacer ring $\varnothing 50$ x $\varnothing 20$ x 10	
350011004	Spacer ring $\varnothing 50$ x $\varnothing 20$ x 4	
350030010	Lock washer $\varnothing 50$ x $\varnothing 20$ x 2	
350020060	Clamping nut $\varnothing 50$ x 6 x M20 x 1 PC27	
350020020	*Clamping nut with balancing option $\varnothing 50$ x 8,5 M20 x 1,0 PC27	

SMP HSK-E40 // Shaft $\varnothing 20$ mm // RS $\varnothing 35$ mm

For SMP tool grinding machines with ring set $\varnothing 35$ mm

GWA HSK-E40 // $\varnothing 20$ mm // RS $\varnothing 35$ mm

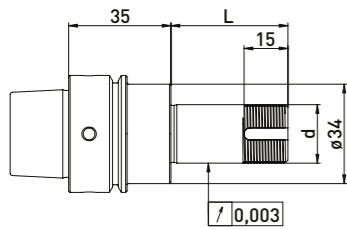
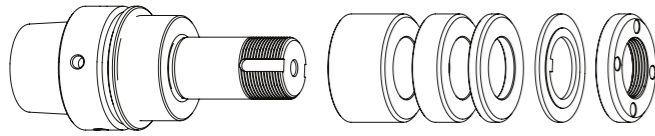

GWA HSK-E40 // $\varnothing 20$ mm // without RS

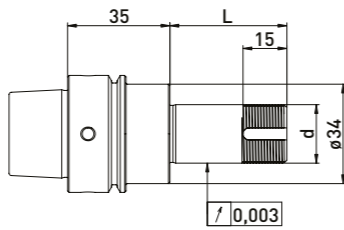
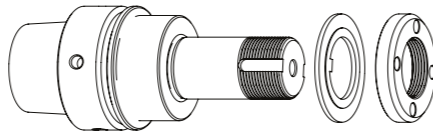

Delivered equipped:

Ring set $\varnothing 35$ mm, lock washer and clamping nut

Delivered equipped:

Lock washer and clamping nut

Order No.	HSK	d	L	Ring set $\varnothing 35$ mm		
				B20	B10	B4
300122512	HSK-E40	20	40	-	1	4
300122522	HSK-E40	20	60	1	1	4
300122532	HSK-E40	20	100	2	3	4

Order No.	HSK	d	L
300122511	HSK-E40	20	40
300122521	HSK-E40	20	60
300122531	HSK-E40	20	100

SMP HSK-E40 // Shaft $\varnothing 20$ mm // RS $\varnothing 50$ mm

For SMP tool grinding machines with ring set $\varnothing 50$ mm

GWA HSK-E40 // $\varnothing 20$ mm // RS $\varnothing 50$ mm

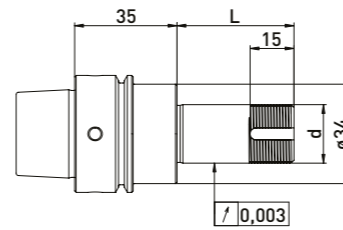
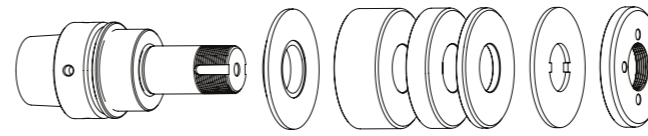

GWA HSK-E40 // $\varnothing 20$ mm // without RS

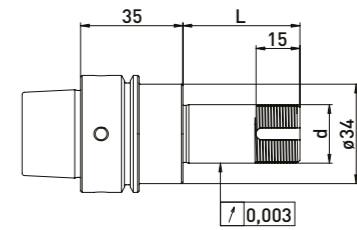
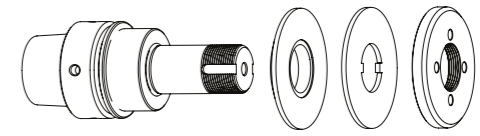

Delivered equipped:

Reducing washer, ring set $\varnothing 50$ mm, lock washer and clamping nut

Delivered equipped:

Reducing washer, lock washer and clamping nut

Order No.	HSK	d	L	Ring set $\varnothing 50$ mm		
				B20	B10	B4
300122012	HSK-E40	20	40	-	1	3
300122022	HSK-E40	20	60	1	1	3
300122032	HSK-E40	20	100	2	3	3

Order No.	HSK	d	L
300122011	HSK-E40	20	40
300122021	HSK-E40	20	60
300122031	HSK-E40	20	100

Accessories SMP grinding wheel adapter HSK-E40 // Shaft $\varnothing 20$ mm // Ring set $\varnothing 35$ mm

Order No.	Name	
350050050	Assembly device $\varnothing 40$	
350040010	Clamping nut wrench PC27 for $\varnothing 20$	
350040011	Clamping nut wrench PC27 for $\varnothing 20$	
350040040	*Clamping nut wrench PC29 for $\varnothing 20$ for clamping nut with blancing option	
350040041	*Clamping nut wrench PC29 for $\varnothing 20$	
350020081	*Balancing weight pair for clamping nut $\varnothing 35$ // 40gmm	

Order No.	Name	
350012020	Spacer ring $\varnothing 35 \times \varnothing 20 \times 20$	
350012010	Spacer ring $\varnothing 35 \times \varnothing 20 \times 10$	
350012004	Spacer ring $\varnothing 35 \times \varnothing 20 \times 4$	
350030020	Lock washer $\varnothing 35 \times \varnothing 20 \times 2$	
350020030	Clamping nut $\varnothing 35 \times 6$ M20 x 1 PC27	
350020080	*Clamping nut with balancing option $\varnothing 35 \times \varnothing 40 \times 8$ x M20 x 1 PC29	
350015005	Support washer $\varnothing 35 \times \varnothing 60 \times \varnothing 20 \times 6$	

Accessories SMP grinding wheel adapter HSK-E40 // Shaft $\varnothing 20$ mm // Ring set $\varnothing 50$ mm

Order No.	Name	
350050050	Assembly device $\varnothing 40$	
350040010	*Clamping nut wrench PC27 for $\varnothing 20$	
350040011	*Clamping nut wrench PC27 for $\varnothing 20$	
350020021	*Balancing weight pair for clamping nut $\varnothing 50$ // 100gmm	

Order No.	Name	
350011020	Spacer ring $\varnothing 50 \times \varnothing 20 \times 20$	
350011010	Spacer ring $\varnothing 50 \times \varnothing 20 \times 10$	
350011004	Spacer ring $\varnothing 50 \times \varnothing 20 \times 4$	
350015001	Reducing washer $\varnothing 50 \times \varnothing 35 \times \varnothing 20 \times 6$	
350030010	Lock washer $\varnothing 50 \times \varnothing 20 \times 2$	
350020060	Clamping nut $\varnothing 50 \times 6$ x M20 x 1 PC27	
350020020	*Clamping nut with balancing option $\varnothing 50 \times 8,5$ M20 x 1,0 PC27	

Strausak similar HSK50 // Shaft $\varnothing 20$ mm // RS $\varnothing 50$ mm

For Strausak Promat tool grinding machines for Ring set $\varnothing 50$ mm

GWA similar HSK50 // $\varnothing 20$ mm // RS $\varnothing 50$ mm

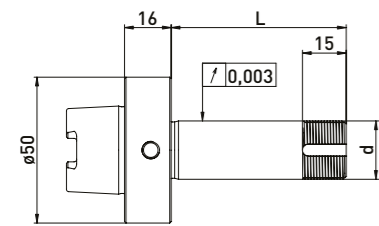
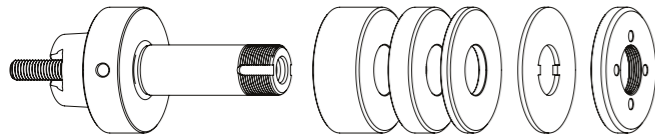

Delivered equipped:
Ring set $\varnothing 50$ mm, lock washer, clamping nut and tightening screw

Order No.	Taper	d	L	Ring set $\varnothing 50$ mm		
				B20	B10	B4
300062032	similar HSK50	20	60	1	1	4

GWA similar HSK50 // $\varnothing 20$ mm // without RS

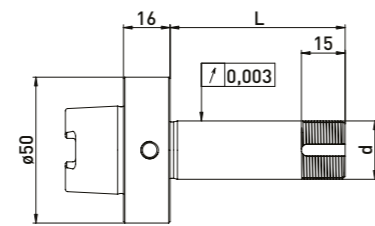
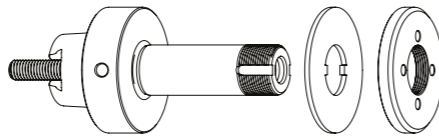

Delivered equipped:
Lock washer, clamping nut and tightening screw

Order No.	Taper	d	L
300062031	similar HSK50	20	60

Strausak similar HSK50 // Shaft $\varnothing 38$ mm // RS $\varnothing 62$ mm

For Strausak Promat tool grinding machines with ring set $\varnothing 62$ mm

GWA similar HSK50 // $\varnothing 38$ mm // RS 62 mm

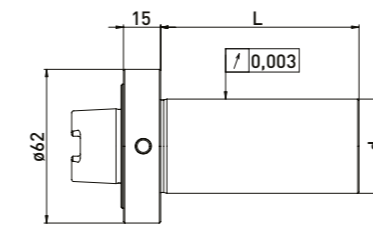
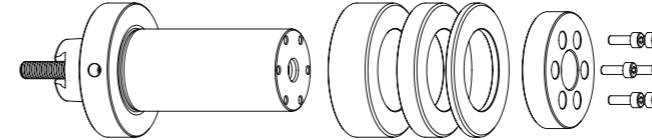

Delivered equipped:
Ring set $\varnothing 62$ mm, clamping flange, 4pc. allen screw and tightening screw

Order No.	Taper	d	L	Ring set $\varnothing 62$ mm		
				B20	B10	B4
300062332	similar HSK50	38	80	2	2	4

GWA similar HSK50 // $\varnothing 38$ mm // without RS

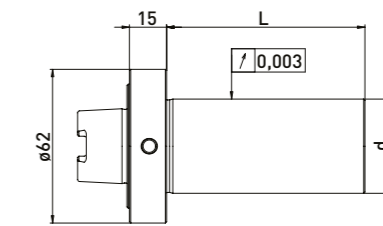
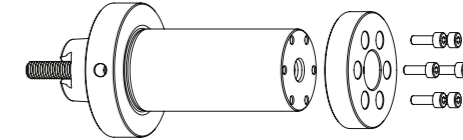

Delivered equipped:
Clamping flange, 4pc. allen screw and tightening screw

Order No.	Taper	d	L
300062331	similar HSK50	38	80

Accessories Strausak Promat grinding wheel adapter similar HSK50 // Shaft $\varnothing 20$ mm // Ring set $\varnothing 50$ mm

Order No.	Name	Order No.	Name
350050010	Universal assembly device $\varnothing 50$	350011020	Spacer ring $\varnothing 50 \times \varnothing 20 \times 20$
350040010	*Clamping nut wrench PC27 for $\varnothing 20$	350011010	Spacer ring $\varnothing 50 \times \varnothing 20 \times 10$
350040011	*Clamping nut wrench PC27 for $\varnothing 20$	350011004	Spacer ring $\varnothing 50 \times \varnothing 20 \times 4$
350020021	*Balancing weight pair for clamping nut $\varnothing 50 // 100$ gmm	350015003	Support washer $\varnothing 50 \times \varnothing 75 \times \varnothing 20 \times 6$
		350030010	Lock washer $\varnothing 50 \times \varnothing 20 \times 2$
		350020060	Clamping nut $\varnothing 50 \times 6 \times M20 \times 1$ PC27
		350020020	*Clamping nut with balancing option $\varnothing 50 \times 8,5 M20 \times 1,0$ PC27

Accessories Strausak Promat grinding wheel adapter similar HSK50 // Shaft $\varnothing 38$ mm // Ring set $\varnothing 62$ mm

Order No.	Name	Order No.	Name
350050040	Assembly device Strausak $\varnothing 62$	350013320	Spacer ring $\varnothing 62 \times \varnothing 38 \times 20$
		350013310	Spacer ring $\varnothing 62 \times \varnothing 38 \times 10$
		350013304	Spacer ring $\varnothing 62 \times \varnothing 38 \times 4$
		350020040	Clamping flange $\varnothing 54 \times 12$

Strausak Internal taper // Shaft $\varnothing 20\text{mm}$ // RS $\varnothing 50\text{ mm}$

For Strausak Fleximat tool grinding machines with ring set $\varnothing 50\text{ mm}$

GWA Strausak Internal taper // $\varnothing 20\text{mm}$ // RS $\varnothing 50\text{ mm}$

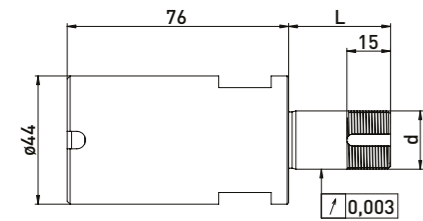
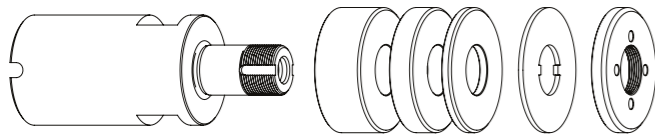

Delivered equipped:

Ring set $\varnothing 50\text{ mm}$, lock washer, clamping nut and clamping screw

Order No.	Internal taper	d	L	Ring set $\varnothing 50\text{ mm}$		
				B20	B10	B4
300063012	Strausak	20	35	-	1	3
300063022	Strausak	20	60	1	1	4

GWA Strausak Internal taper // $\varnothing 20\text{mm}$ // without RS

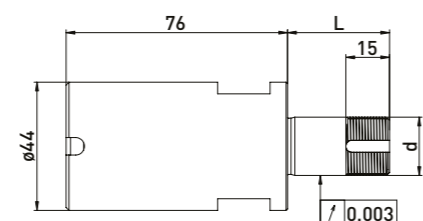
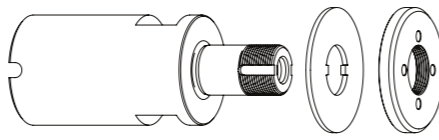

Delivered equipped:

Lock washer, clamping nut and clamping screw

Order No.	Internal taper	d	L
300063011	Strausak	20	35
300063021	Strausak	20	60

Strausak Internal taper // Shaft $\varnothing 38\text{mm}$ // RS $\varnothing 62\text{ mm}$

For Strausak Fleximat tool grinding machines with ring set $\varnothing 62\text{ mm}$

GWA Strausak Internal taper // $\varnothing 38\text{mm}$ // RS $\varnothing 62\text{ mm}$

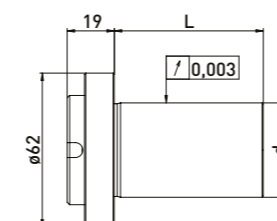
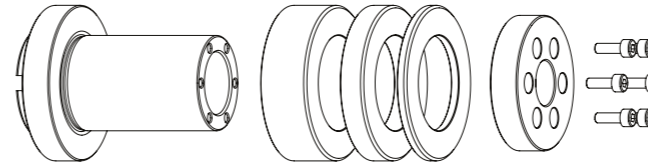

Delivered equipped:

Ring set $\varnothing 62\text{ mm}$, clamping flange, allen screw 4pc. and tightening screw

Order No.	Internal taper	d	L	Ring set $\varnothing 62\text{ mm}$		
				B20	B10	B4
300063332	Strausak	38	60	1	2	4

GWA Strausak Internal taper // $\varnothing 38\text{ mm}$ // without RS

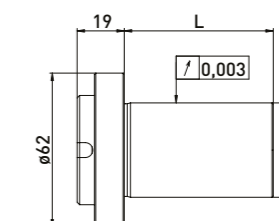
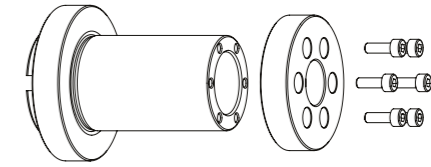

Delivered equipped:

clamping flange, allen screw 4pc. and tightening screw

Order No.	Internal taper	d	L
300063331	Strausak	38	60

Accessories Strausak Fleximat grinding wheel adapter Strausak Internal taper // Shaft $\varnothing 20\text{ mm}$ // Ring set $\varnothing 50\text{ mm}$

Order No.	Name	Order No.	Name
350050010	Universal assembly device $\varnothing 50$	350011020	Spacer ring $\varnothing 50 \times \varnothing 20 \times 20$
350015007	Adapter sleeve Strausak clamping diameter $\varnothing 44$ [Reduction for Strausak $\varnothing 44 \times \varnothing 50$ for universal assembly device]	350011010	Spacer ring $\varnothing 50 \times \varnothing 20 \times 10$
350040010	*Clamping nut wrench PC27 for $\varnothing 20$	350011004	Spacer ring $\varnothing 50 \times \varnothing 20 \times 4$
350040011	*Clamping nut wrench PC27 for $\varnothing 20$	350030010	Lock washer $\varnothing 50 \times \varnothing 20 \times 2$
350020021	*Balancing weight pair for clamping nut $\varnothing 50 // 100\text{gmm}$	350020060	Clamping nut $\varnothing 50 \times 6 \times \text{M}20 \times 1 \text{ PC}27$
		350020020	*Clamping nut with balancing option $\varnothing 50 \times 8,5 \text{ M}20 \times 1,0 \text{ PC}27$

Accessories Strausak Fleximat grinding wheel adapter Strausak Internal taper // Shaft $\varnothing 38\text{ mm}$ // Ring set $\varnothing 62\text{mm}$

Order No.	Name	Order No.	Name
350050040	Assembly device Strausak $\varnothing 62$	350013320	Spacer ring $\varnothing 62 \times \varnothing 38 \times 20$
		350013310	Spacer ring $\varnothing 62 \times \varnothing 38 \times 10$
		350013304	Spacer ring $\varnothing 62 \times \varnothing 38 \times 4$
		350020040	Clamping flange $\varnothing 54 \times 12$

Strausak HSK-E50 // Shaft $\varnothing 20$ mm // RS $\varnothing 50$ mm

For Strausak tool grinding machines with ring set $\varnothing 50$ mm

GWA HSK-E50 // $\varnothing 20$ mm // RS $\varnothing 50$ mm

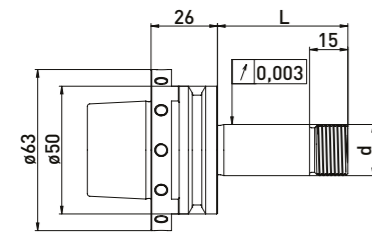
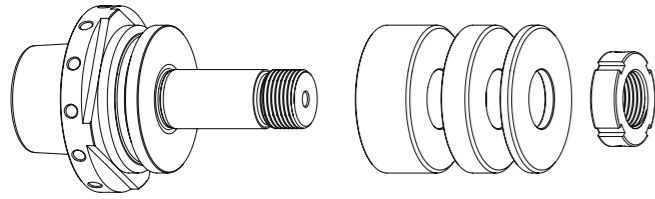

Delivered equipped:
Ring set $\varnothing 50$ mm and clamping nut

GWA HSK-E50 // $\varnothing 20$ mm // without RS

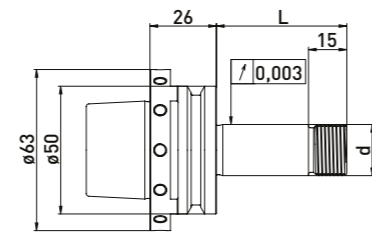
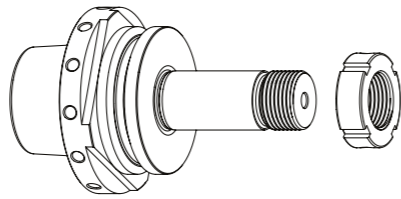

Delivered equipped:
Clamping nut

Ring set $\varnothing 50$ mm

Order No.	HSK	d	L	B20	B10	B4
300150612	HSK-50	20	51	1	1	2
300150632	HSK-50	20	81	2	2	2

Order No.	HSK	d	L
300150611	HSK-50	20	51
300150631	HSK-50	20	81

Strausak HSK-E50 // Shaft $\varnothing 31,75$ mm (1¼) // RS $\varnothing 60$ mm

For Strausak tool grinding machines with ring set $\varnothing 60$ mm

GWA HSK-E50 // $\varnothing 31,75$ mm // RS $\varnothing 60$ mm

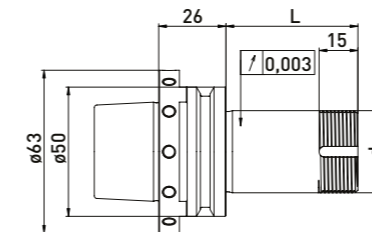
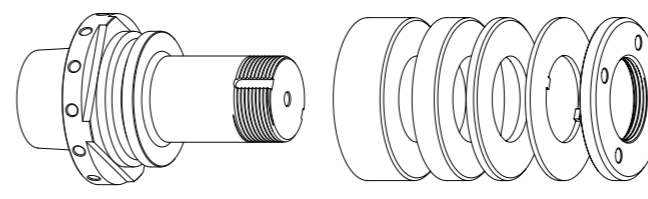

Delivered equipped:
Ring set $\varnothing 60$ mm, lock washer and clamping nut

GWA HSK-E50 // $\varnothing 31,75$ mm // without RS

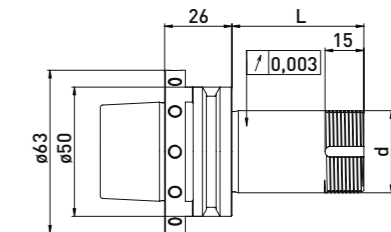
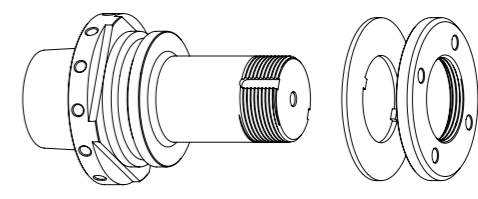

Delivered equipped:
Lock washer and clamping nut

Ring set $\varnothing 60$ mm

Order No.	HSK	d	L	B20	B10	B4
300150712	HSK-50E	31,75	51	-	1	3
300150732	HSK-50E	31,75	81	1	1	3

Order No.	HSK	d	L
300150711	HSK-50E	31,75	51
300150731	HSK-50E	31,75	81

Accessories Strausak grinding wheel adapter HSK-E50 // Shaft $\varnothing 20$ mm // Ring set $\varnothing 50$ mm

Order No.	Name	Order No.	Name
350040051	Hook wrench 30 - 32 mm	350011520	Spacer ring Rollomatic $\varnothing 50 \times \varnothing 20 \times 20$
		350011510	Spacer ring Rollomatic $\varnothing 50 \times \varnothing 20 \times 10$
		350011504	Spacer ring Rollomatic $\varnothing 50 \times \varnothing 20 \times 4$
		350020121	Clamping nut MRR20 x 1,5 M20 x 1,5 $\varnothing 32 \times 10$
		350015003	Support washer $\varnothing 50 \times \varnothing 75 \times \varnothing 20 \times 6$

Accessories Strausak grinding wheel adapter HSK-E50 // $\varnothing 31,75$ mm (1¼) // Ring set $\varnothing 60$ mm

Order No.	Name	Order No.	Name
350040030	*Clamping nut wrench PC39 for clamping nut with blancing option	350011420	Spacer ring $\varnothing 60 \times \varnothing 31,75 \times 20$
350040020	Clamping nut wrench PC45 for $\varnothing 32$	350011410	Spacer ring $\varnothing 60 \times \varnothing 31,75 \times 10$
350020023	*Balancing weight pair for clamping nut $\varnothing 60$ // 200gmm	350011404	Spacer ring $\varnothing 60 \times \varnothing 31,75 \times 4$
		350030060	Lock washer $\varnothing 60 \times \varnothing 32 \times 1,8$
		350020066	Clamping nut $\varnothing 60 \times 6 \times M32 \times 1,5$ PC45
		350020022	*Clamping nut with balancing option $\varnothing 60 \times 9$ M32 x 1,5 PC39

TTB HSK-F40 // Shaft $\varnothing 20$ mm // RS $\varnothing 35$ mm

For TTB tool grinding machines with ring set $\varnothing 35$ mm

GWA HSK-F40 // $\varnothing 20$ mm // RS $\varnothing 35$ mm

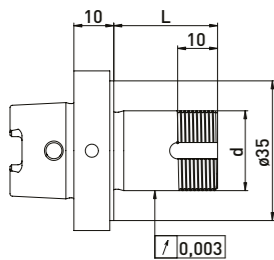
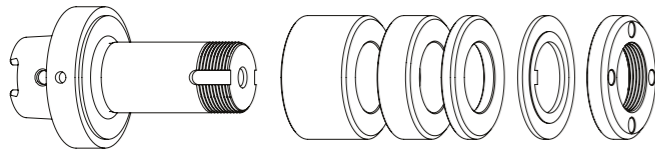

Delivered equipped:
Ring set $\varnothing 35$ mm, lock washer and clamping nut

Order No.	HSK	d	L	Ring set $\varnothing 35$ mm		
				B20	B10	B4
300132012	HSK-F40	20	26	-	-	4
300132022	HSK-F40	20	42	-	2	3
300132032	HSK-F40	20	60	1	2	3

Accessories TTB grinding wheel adapter HSK-F40 // Shaft $\varnothing 20$ mm // Ring set $\varnothing 35$ mm

Order No.	Name	Order No.	Name
350050050	Assembly device $\varnothing 40$	350012020	Spacer ring $\varnothing 35 \times \varnothing 20 \times 20$
350040010	Clamping nut wrench PC27 for $\varnothing 20$	350012010	Spacer ring $\varnothing 35 \times \varnothing 20 \times 10$
350040011	Clamping nut wrench PC27 for $\varnothing 20$	350012004	Spacer ring $\varnothing 35 \times \varnothing 20 \times 4$
350040040	*Clamping nut wrench PC29 for $\varnothing 20$ for clamping nut with blancing option	350030020	Lock washer $\varnothing 35 \times \varnothing 20 \times 2$
350040041	*Clamping nut wrench PC29 for $\varnothing 20$	350020030	Clamping nut $\varnothing 35 \times 6$ M20 x 1 PC27
350020081	*Balancing weight pair for clamping nut $\varnothing 35 // 40$ gmm	350020080	*Clamping nut with balancing option $\varnothing 35 \times \varnothing 40 \times 8$ x M20 x 1 PC29
		350015005	Support washer $\varnothing 35 \times \varnothing 60 \times \varnothing 20 \times 6$

Vollmer HSK50 // Schaft $\varnothing 20$ mm // RS $\varnothing 35$ mm

For Vollmer VGRIND tool grinding machines with ring set $\varnothing 35$ mm

GWA HSK50 // $\varnothing 20$ mm // RS $\varnothing 35$ mm

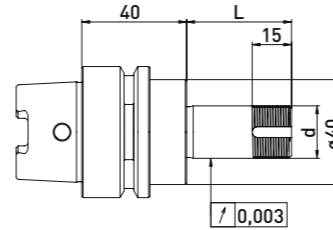
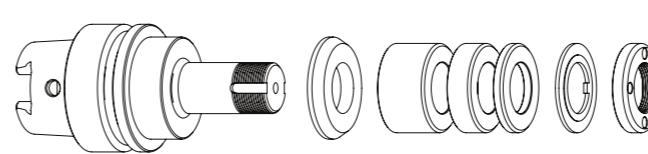

Delivered equipped:
Reducing washer, ring set $\varnothing 35$ mm, lock washer and clamping nut

Order No.	HSK	d	L	Ring set $\varnothing 35$ mm		
				B20	B10	B4
300012512	HSK50	20	40	-	1	3
300012522	HSK50	20	60	1	1	3
300012532	HSK50	20	75	1	2	4
300012542	HSK50	20	85	2	1	4
300012552	HSK50	20	100	2	3	3

Accessories Vollmer grinding wheel adapter HSK50 // $\varnothing 20$ mm // Ring set $\varnothing 35$ mm

Order No.	Name	Order No.	Name
350050010	Universal assembly device $\varnothing 50$	350012020	Spacer ring $\varnothing 35 \times \varnothing 20 \times 20$
350040010	Clamping nut wrench PC27 for $\varnothing 20$	350012010	Spacer ring $\varnothing 35 \times \varnothing 20 \times 10$
350040011	Clamping nut wrench PC27 for $\varnothing 20$	350012004	Spacer ring $\varnothing 35 \times \varnothing 20 \times 4$
350040040	*Clamping nut wrench PC29 for $\varnothing 20$ for clamping nut with blancing option	350015006	Reducing washer $\varnothing 40 \times \varnothing 35 \times \varnothing 20 \times 6$
350040041	*Clamping nut wrench PC29 for $\varnothing 20$	350030020	Lock washer $\varnothing 35 \times \varnothing 20 \times 2$
350020081	*Balancing weight pair for clamping nut $\varnothing 35 // 40$ gmm	350020030	Clamping nut $\varnothing 35 \times 6$ M20 x 1 PC27
		350020080	*Clamping nut with balancing option $\varnothing 35 \times \varnothing 40 \times 8$ x M20 x 1 PC29
		350015005	Support washer $\varnothing 35 \times \varnothing 60 \times \varnothing 20 \times 6$

*related items

Vollmer HSK50 // Shaft $\varnothing 20$ mm // RS $\varnothing 50$ mm

For Vollmer VGRIND tool grinding machines with ring set $\varnothing 50$ mm

GWA HSK50 // $\varnothing 20$ mm // RS $\varnothing 50$ mm

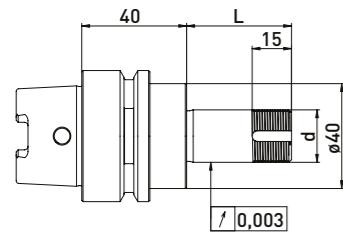
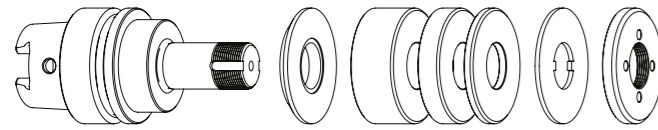

Delivered equipped:

Reducing washer, ring set $\varnothing 50$ mm, lock washer and clamping nut

Order No.	HSK	d	L	Ring set $\varnothing 50$ mm		
				B20	B10	B4
300012012	HSK50	20	40	-	1	3
300012022	HSK50	20	60	1	1	3
300012032	HSK50	20	75	1	2	4
300012042	HSK50	20	85	2	1	4
300012052	HSK50	20	100	2	3	3

GWA HSK50 // $\varnothing 20$ mm // without RS

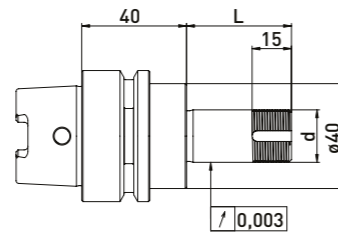
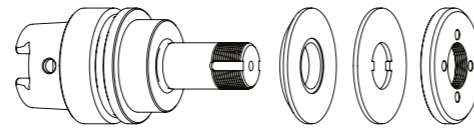

Delivered equipped:

Reducing washer, lock washer and clamping nut

Order No.	HSK	d	L
300012011	HSK50	20	40
300012021	HSK50	20	60
300012031	HSK50	20	75
300012041	HSK50	20	85
300012051	HSK50	20	100

Accessories Vollmer grinding wheel adapter HSK50 // $\varnothing 20$ mm // Ring set $\varnothing 50$ mm

Order No.	Name	
350050010	Universal assembly device $\varnothing 50$	
350040010	*Clamping nut wrench PC27 for $\varnothing 20$	
350040011	*Clamping nut wrench PC27 for $\varnothing 20$	
350020021	*Balancing weight pair for clamping nut $\varnothing 50$ // 100gmm	

Order No.	Name	
350011020	Spacer ring $\varnothing 50$ x $\varnothing 20$ x 20	
350011010	Spacer ring $\varnothing 50$ x $\varnothing 20$ x 10	
350011004	Spacer ring $\varnothing 50$ x $\varnothing 20$ x 4	
350015002	Reducing washer $\varnothing 40$ x $\varnothing 50$ x $\varnothing 20$ x 6	
350030010	Lock washer $\varnothing 50$ x $\varnothing 20$ x 2	
350020060	Clamping nut $\varnothing 50$ x 6 x M20 x 1 PC27	
350020020	*Clamping nut with balancing option $\varnothing 50$ x 8,5 M20 x 1,0 PC27	
350015003	Support washer $\varnothing 50$ x $\varnothing 75$ x $\varnothing 20$ x 6	

Walter HSK40 // stepped Shaft $\varnothing 20, \varnothing 32$ // RS $\varnothing 50$ and $\varnothing 60$ mm

For Walter tool grinding machines with ring set $\varnothing 50$ and $\varnothing 60$ mm

GWA HSK40 // stepped $\varnothing 20 \varnothing 32$ mm // RS $\varnothing 50 \varnothing 60$ mm

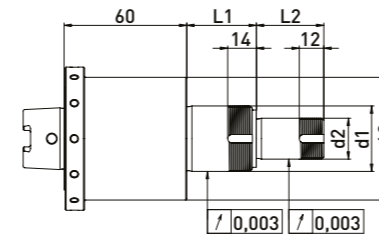
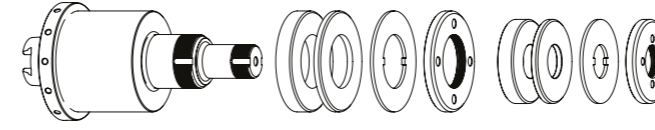

Delivered equipped:

Ring set $\varnothing 50$ and $\varnothing 60$ mm, lock washer and clamping nut

Order No.	HSK	d1	d2	L1	L2	Ring set $\varnothing 50$ mm		Ring set $\varnothing 60$ mm	
						B20	B4	B10	B4
300103012	HSK40	32	20	34	33	1	2	1	2

Accessories Walter grinding wheel adapter HSK40 // stepped Shaft $\varnothing 20, \varnothing 30$ // RS $\varnothing 50$ and $\varnothing 60$ mm

Accessories $\varnothing 50$ mm

Order No.	Name	
350011020	Spacer ring $\varnothing 50$ x $\varnothing 20$ x 20	
350011010	Spacer ring $\varnothing 50$ x $\varnothing 20$ x 10	
350011004	Spacer ring $\varnothing 50$ x $\varnothing 20$ x 4	
350030010	Lock washer $\varnothing 50$ x $\varnothing 20$ x 2	
350020060	Clamping nut $\varnothing 50$ x 6 x M20 x 1 PC27	
350020020	*Clamping nut with balancing option $\varnothing 50$ x 8,5 M20 x 1,0 PC27	
350020021	*Balancing weight pair for clamping nut $\varnothing 50$ // 100gmm	
350040010	*Clamping nut wrench PC27 for $\varnothing 20$	
350040011	*Clamping nut wrench PC27 for $\varnothing 20$	

Accessories $\varnothing 60$ mm

Order No.	Name	
350011320	Spacer ring $\varnothing 60$ x $\varnothing 32$ x 20	
350011310	Spacer ring $\varnothing 60$ x $\varnothing 32$ x 10	
350011304	Spacer ring $\varnothing 60$ x $\varnothing 32$ x 4	
350030060	Lock washer $\varnothing 60$ x $\varnothing 32$ x 1,8	
350020065	Clamping nut $\varnothing 60$ x 6 x M32x1 PC45	
350040020	Clamping nut wrench PC45 for $\varnothing 32$	

Walter HSK40 // Shaft $\varnothing 20$ / Shaft $\varnothing 32$ mm // RS $\varnothing 50$ and $\varnothing 60$ mm

For Walter tool grinding machines with ring set $\varnothing 50$ and $\varnothing 60$ mm

GWA HSK40 // $\varnothing 20$ / $\varnothing 32$ mm // RS $\varnothing 50$ / $\varnothing 60$ mm

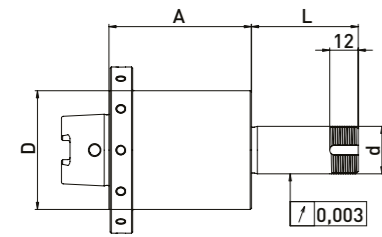
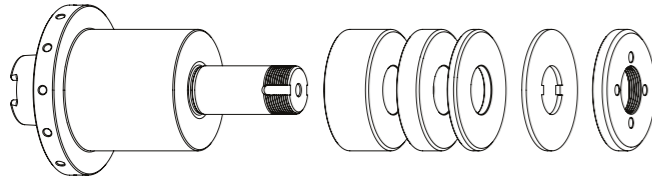

Delivered equipped:

Ring set $\varnothing 50$ mm or ring set $\varnothing 60$, lock washer and clamping nut

Walter HSK40 // Shaft $\varnothing 20$ // Ring set $\varnothing 50$ mm

Order No.	HSK	d	D	A	L	B20	B10	B4
300103112	HSK40	20	50	60	45	-	2	3
300103122	HSK40	20	50	80	52	1	1	3

Accessories $\varnothing 50$ mm

Order No.	Name	
350011020	Spacer ring $\varnothing 50$ x $\varnothing 20$ x 20	
350011010	Spacer ring $\varnothing 50$ x $\varnothing 20$ x 10	
350011004	Spacer ring $\varnothing 50$ x $\varnothing 20$ x 4	
350030010	Lock washer $\varnothing 50$ x $\varnothing 20$ x 2	
350020060	Clamping nut $\varnothing 50$ x 6 x M20 x 1 PC27	
350020020	*Clamping nut with balancing option $\varnothing 50$ x 8,5 M20 x 1,0 PC27	
350020021	*Balancing weight pair for clamping nut $\varnothing 50$ // 100gmm	
350040010	*Clamping nut wrench PC27 for $\varnothing 20$	
350040011	*Clamping nut wrench PC27 for $\varnothing 20$	

Walter HSK40 // Shaft $\varnothing 32$ and $31,75$ // Ring set $\varnothing 60$ mm

Order No.	HSK	d	D	A	L	B10	B4
300103132	HSK40	32	60	60	42	2	3
300103142	HSK40	31,75	60	60	45	1	1

Accessories $\varnothing 60$ mm

Order No.	Name	
350011320	Spacer ring $\varnothing 60$ x $\varnothing 32$ x 20	
350011310	Spacer ring $\varnothing 60$ x $\varnothing 32$ x 10	
350011304	Spacer ring $\varnothing 60$ x $\varnothing 32$ x 4	
350011420	Spacer ring $\varnothing 60$ x $\varnothing 31,75$ x 20	
350011410	Spacer ring $\varnothing 60$ x $\varnothing 31,75$ x 10	
350011404	Spacer ring $\varnothing 60$ x $\varnothing 31,75$ x 4	
350030060	Lock washer $\varnothing 60$ x $\varnothing 32$ x 1,8	
350020066	Clamping nut $\varnothing 60$ x 6 x M32 x 1,5 PC45	
350020022	*Clamping nut with balancing option $\varnothing 60$ x 9 M32 x 1,5 PC39	
350040030	*Clamping nut wrench TK39 for clamping nut with balancing option	
350040020	Clamping nut wrench PC45 for $\varnothing 32$	
350020023	*Balancing weight pair for clamping nut $\varnothing 60$ // 200gmm	

Walter HSK50 // Shaft $\varnothing 20$ mm // RS $\varnothing 35$ mm

For Walter tool grinding machines with ring set $\varnothing 35$ mm

GWA HSK50 // $\varnothing 20$ mm // RS $\varnothing 35$ mm

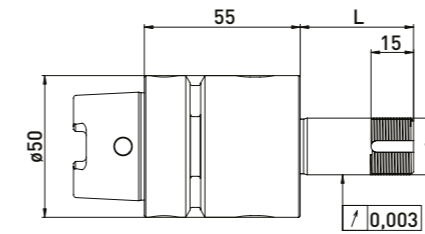
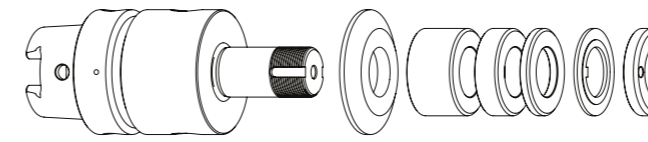

Delivered equipped:

Reducing washer, ring set $\varnothing 35$ mm, lock washer and clamping nut

Ring set $\varnothing 35$ mm

Order No.	HSK	d	L	B20	B10	B4
300102512	HSK50	20	40	-	1	3
300102522	HSK50	20	60	1	1	3
300102532	HSK50	20	85	2	2	4
300102542	HSK50	20	100	2	3	3

GWA HSK50 // $\varnothing 20$ mm // without RS

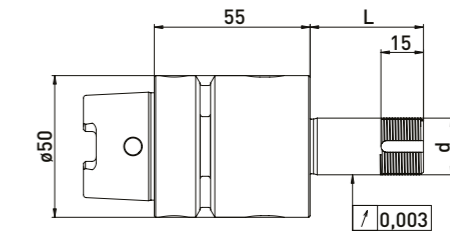
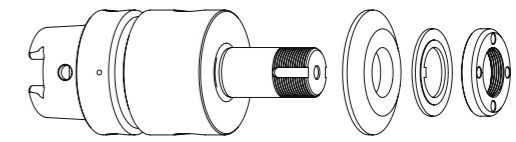

Delivered equipped:

Reducing washer, lock washer and clamping nut

Order No.	HSK	d	L
300102511	HSK50	20	40
300102521	HSK50	20	60
300102531	HSK50	20	85
300102541	HSK50	20	100

Accessories Walter grinding wheel adapter HSK50 // Shaft $\varnothing 20$ mm // Ring set $\varnothing 35$ mm

Order No.	Name	
350050010	Universal assembly device $\varnothing 50$	
350040010	Clamping nut wrench PC27 for $\varnothing 20$	
350040011	Clamping nut wrench PC27 for $\varnothing 20$	
350040040	*Clamping nut wrench PC29 for $\varnothing 20$ for clamping nut with balancing option	
350040041	*Clamping nut wrench PC29 for $\varnothing 20$	
350020081	*Balancing weight pair for clamping nut $\varnothing 35$ // 40gmm	

Order No.	Name	
350012020	Spacer ring $\varnothing 35$ x $\varnothing 20$ x 20	
350012010	Spacer ring $\varnothing 35$ x $\varnothing 20$ x 10	
350012004	Spacer ring $\varnothing 35$ x $\varnothing 20$ x 4	
350015001	Reducing washer $\varnothing 50$ x $\varnothing 35$ x $\varnothing 20$ x 6	
350030020	Lock washer $\varnothing 35$ x $\varnothing 20$ x 2	
350020030	Clamping nut $\varnothing 35$ x 6 M20 x 1 PC27	
350020080	*Clamping nut with balancing option $\varnothing 35$ x $\varnothing 40$ x 8 x M20 x 1 PC29	
350015005	Support washer $\varnothing 35$ x $\varnothing 60$ x $\varnothing 20$ x 6	

Walter HSK50 // Shaft $\varnothing 20$ mm // RS $\varnothing 50$ mm

For Walter tool grinding machines with ring set $\varnothing 50$ mm

GWA HSK50 // $\varnothing 20$ mm // RS $\varnothing 50$ mm

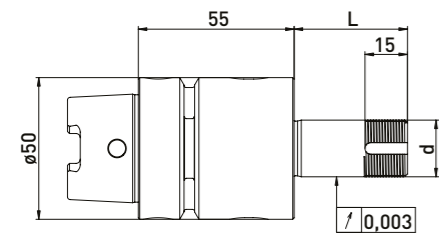
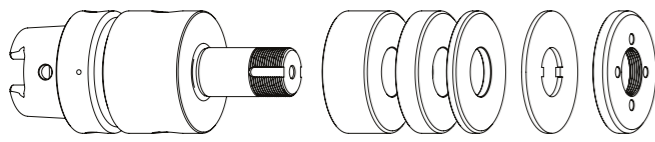

Delivered equipped:

Ring set $\varnothing 50$ mm, lock washer and clamping nut

GWA HSK50 // $\varnothing 20$ mm // without RS

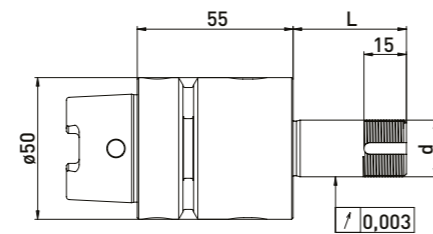
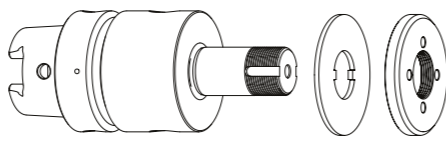

Delivered equipped:

Lock washer and clamping nut

Ring set $\varnothing 50$ mm

Order No.	HSK	d	L	B20	B10	B4
300102012	HSK50	20	40	-	2	3
300102022	HSK50	20	60	1	2	3
300102032	HSK50	20	85	2	2	4
300102042	HSK50	20	100	2	3	5

Order No.	HSK	d	L
300102011	HSK50	20	40
300102021	HSK50	20	60
300102031	HSK50	20	85
300102041	HSK50	20	100

Accessories Walter grinding wheel adapter HSK50 // Shaft $\varnothing 20$ mm // Ring set $\varnothing 50$ mm

Order No.	Name
350050010	Universal assembly device $\varnothing 50$
350040010	*Clamping nut wrench PC27 for $\varnothing 20$
350040011	*Clamping nut wrench PC27 for $\varnothing 20$
350020021	*Balancing weight pair for clamping nut $\varnothing 50$ // 100gmm

Order No.	Name
350011020	Spacer ring $\varnothing 50 \times \varnothing 20 \times 20$
350011010	Spacer ring $\varnothing 50 \times \varnothing 20 \times 10$
350011004	Spacer ring $\varnothing 50 \times \varnothing 20 \times 4$
350015002	Reducing washer $\varnothing 40 \times \varnothing 50 \times \varnothing 20 \times 6$
350020060	Clamping nut $\varnothing 50 \times 6 \times M20 \times 1$ PC27
350020020	*Clamping nut with balancing option $\varnothing 50 \times 8,5 M20 \times 1,0$ PC27

Walter HSK50 // Shaft $\varnothing 31,75$ mm (1 1/4) // RS $\varnothing 60$ mm

For Walter tool grinding machines with ring set $\varnothing 60$ mm

GWA HSK50 // $\varnothing 31,75$ mm (1 1/4) // RS $\varnothing 60$ mm

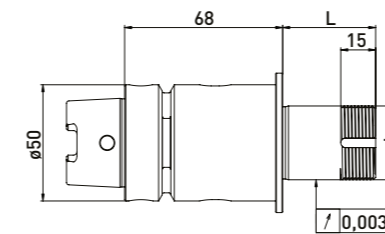
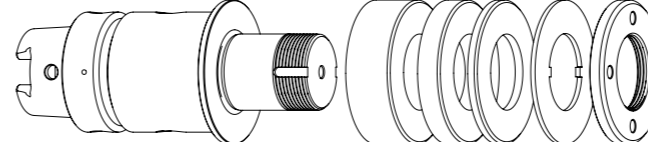

Delivered equipped:

Ring set $\varnothing 60$ mm, lock washer and clamping nut

GWA HSK50 // $\varnothing 31,75$ mm (1 1/4) // without RS

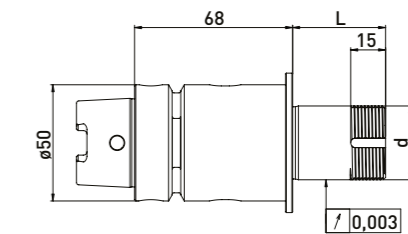
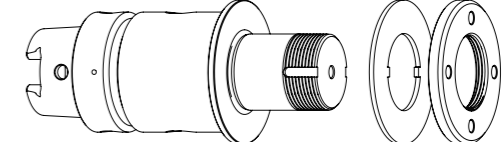

Delivered equipped:

Lock washer and clamping nut

Ring set $\varnothing 60$ mm

Order No.	HSK	d	L	B20	B10	B4
300102112	HSK50	31,75	40	-	2	3
300102122	HSK50	31,75	60	1	2	3
300102132	HSK50	31,75	85	2	2	4
300102142	HSK50	31,75	100	3	2	3

Order No.	HSK	d	L
300102111	HSK50	31,75	40
300102121	HSK50	31,75	60
300102131	HSK50	31,75	85
300102141	HSK50	31,75	100

Accessories Walter grinding wheel adapter HSK50 // Shaft $\varnothing 31,75$ mm (1 1/4) // Ring set $\varnothing 60$ mm

Order No.	Name
350050010	Universal assembly device $\varnothing 50$
350040030	*Clamping nut wrench PC39 for clamping nut with blancing option
350040020	Clamping nut wrench PC45 for $\varnothing 32$
350020023	*Balancing weight pair for clamping nut $\varnothing 60$ // 200gmm

Order No.	Name
350011420	Spacer ring $\varnothing 60 \times \varnothing 31,75 \times 20$
350011410	Spacer ring $\varnothing 60 \times \varnothing 31,75 \times 10$
350011404	Spacer ring $\varnothing 60 \times \varnothing 31,75 \times 4$
350030060	Lock washer $\varnothing 60 \times \varnothing 32 \times 1,8$
350020066	Clamping nut $\varnothing 60 \times 6 \times M32 \times 1,5$ PC45
350020022	*Clamping nut with balancing option $\varnothing 60 \times 9 M32 \times 1,5$ PC39

Walter NCT // Shaft $\varnothing 20$ mm // RS $\varnothing 35$ mm

For Walter tool grinding machines with ring set $\varnothing 35$ mm

GWA NCT $\varnothing 31,75$ mm (1 1/4) // $\varnothing 20$ mm // RS $\varnothing 35$ mm

Tight with torque wrench 80Nm.

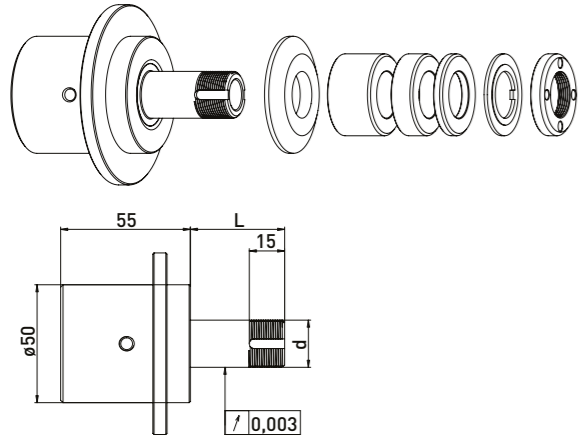

Delivered equipped:

Reducing washer, ring set $\varnothing 35$ mm, lock washer and clamping nut

GWA NCT $\varnothing 31,75$ mm (1 1/4) // $\varnothing 20$ mm // without RS

Tight with torque wrench 80Nm.

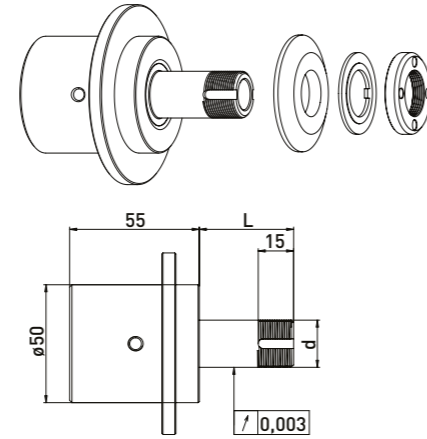

Delivered equipped:

Reducing washer, lock washer and clamping nut

Ring set $\varnothing 35$ mm

Order No.	Internal taper	d	L	B20	B10	B4
300101512	31,75	20	40	-	1	3
300101522	31,75	20	60	1	1	3
300101542	31,75	20	85	2	1	4
300101532	31,75	20	100	2	3	3

Order No.	Internal taper	d	L
300101511	31,75	20	40
300101521	31,75	20	60
300101541	31,75	20	85
300101531	31,75	20	100

Walter NCT // Shaft $\varnothing 20$ mm // RS $\varnothing 50$ mm

For Walter tool grinding machines with ring set $\varnothing 50$ mm

GWA NCT $\varnothing 31,75$ mm (1 1/4) // $\varnothing 20$ mm // RS $\varnothing 50$ mm

Tight with torque wrench 80Nm.

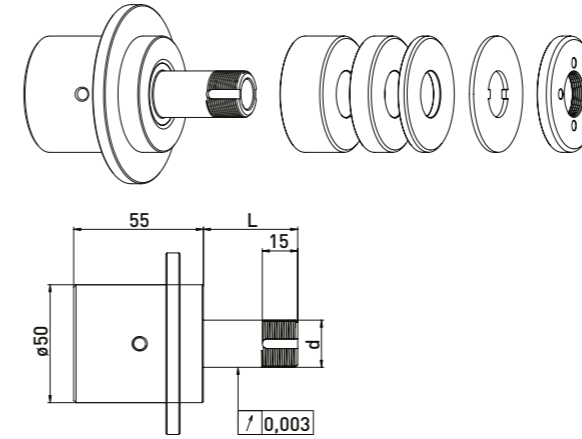

Delivered equipped:

Ring set $\varnothing 50$ mm, lock washer and clamping nut

GWA NCT $\varnothing 31,75$ mm (1 1/4) // $\varnothing 20$ mm // without RS

Tight with torque wrench 80Nm.

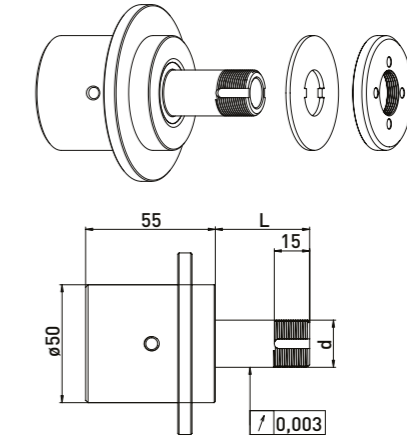

Delivered equipped:

Lock washer and clamping nut

Ring set $\varnothing 50$ mm

Order No.	Internal taper	d	L	B20	B10	B4
300101012	31,75	20	40	-	1	3
300101022	31,75	20	60	1	1	3
300101042	31,75	20	85	2	1	4
300101032	31,75	20	100	2	3	3

Order No.	Internal taper	d	L
300101011	31,75	20	40
300101021	31,75	20	60
300101041	31,75	20	85
300101031	31,75	20	100

Accessories Walter grinding wheel adapter NCT // Shaft $\varnothing 20$ mm // Ring set $\varnothing 35$ mm

Order No.	Name	Order No.	Name
350050010	Universal Assembly device $\varnothing 50$	350012020	Spacer ring $\varnothing 35 \times \varnothing 20 \times 20$
350040010	Clamping nut wrench PC27 for $\varnothing 20$	350012010	Spacer ring $\varnothing 35 \times \varnothing 20 \times 10$
350040011	Clamping nut wrench PC27 for $\varnothing 20$	350012004	Spacer ring $\varnothing 35 \times \varnothing 20 \times 4$
350040040	*Clamping nut wrench PC29 for $\varnothing 20$ for clamping nut with blancing option	350015001	Reducing washer $\varnothing 50 \times \varnothing 35 \times \varnothing 20 \times 6$
350040041	*Clamping nut wrench PC29 for $\varnothing 20$	350030020	Lock washer $\varnothing 35 \times \varnothing 20 \times 2$
350020081	*Balancing weight pair for clamping nut $\varnothing 35 // 40$ gmm	350020030	Clamping nut $\varnothing 35 \times 6$ M20 x 1 PC27
300101001	Installation kit for NCT63 Walter	350020080	*Clamping nut with balancing option $\varnothing 35 \times \varnothing 40 \times 8$ x M20 x 1 PC29
300101003	Assembly wrench for installation kit NCT63 M20 x 1,5	350015005	Support washer $\varnothing 35 \times \varnothing 60 \times \varnothing 20 \times 6$

Accessories Walter grinding wheel adapter NCT // Shaft $\varnothing 20$ mm // Ring set $\varnothing 50$ mm

Order No.	Name	Order No.	Name
350050010	Universal Assembly device $\varnothing 50$	350011020	Spacer ring $\varnothing 50 \times \varnothing 20 \times 20$
350040010	*Clamping nut wrench PC27 for $\varnothing 20$	350011010	Spacer ring $\varnothing 50 \times \varnothing 20 \times 10$
350040011	*Clamping nut wrench PC27 for $\varnothing 20$	350011004	Spacer ring $\varnothing 50 \times \varnothing 20 \times 4$
350040040	*Clamping nut wrench PC29 for $\varnothing 20$ for clamping nut with blancing option	350030010	Lock washer $\varnothing 50 \times \varnothing 20 \times 2$
350040041	*Clamping nut wrench PC29 for $\varnothing 20$	350020060	Clamping nut $\varnothing 50 \times 6$ x M20 x 1 PC27
350020021	*Balancing weight pair for clamping nut $\varnothing 50 // 100$ gmm	350020020	*Clamping nut with balancing option $\varnothing 50 \times 8,5$ M20 x 1,0 PC27
300101001	Installation kit for NCT63 Walter		
300101003	Assembly wrench for installation kit NCT63 M20 x 1,5		

Walter NCT // Shaft $\varnothing 31,75$ mm (1¼) // RS $\varnothing 60$ mm

For Walter tool grinding machines with ring set $\varnothing 60$ mm

GWA NCT $\varnothing 31,75$ mm // $\varnothing 31,75$ mm (1¼) // RS $\varnothing 60$ mm

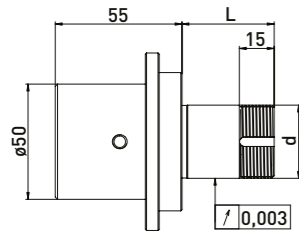
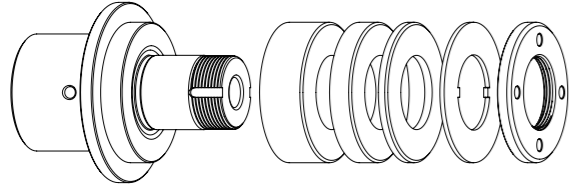

Delivered equipped:
Ring set $\varnothing 60$ mm, lock washer and clamping nut

GWA NCT $\varnothing 31,75$ mm (1¼) // $\varnothing 31,75$ mm (1¼) // without RS

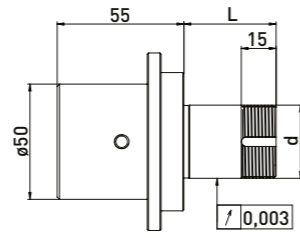
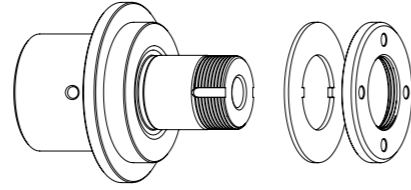

Delivered equipped:
Lock washer and clamping nut

Ring set $\varnothing 60$ mm

Order No.	Internal taper	d	L	B20	B10	B4
300101112	31,75	31,75	40	-	1	5
300101122	31,75	31,75	60	1	1	5
300101132	31,75	31,75	85	1	4	4
300101142	31,75	31,75	100	2	3	5

Order No.	Internal taper	d	L
300101111	31,75	31,75	40
300101121	31,75	31,75	60
300101131	31,75	31,75	85
300101141	31,75	31,75	100

Accessories Walter grinding wheel adapter NCT // Shaft $\varnothing 31,75$ mm (1¼) // Ring set $\varnothing 50$ mm

Order No.	Name	
350050010	Universal Assembly device $\varnothing 50$	
350040030	*Clamping nut wrench PC39 for clamping nut with blancing option	
350040020	Clamping nut wrench PC45 for $\varnothing 32$	
350020023	*Balancing weight pair for clamping nut $\varnothing 60$ // 200gmm	
300101001	Installation kit for NCT63 Walter	
300101003	Assembly wrench for installation kit NCT63 M20 x 1,5	

Order No.	Name	
350011420	Spacer ring $\varnothing 60$ x $\varnothing 31,75$ x 20	
350011410	Spacer ring $\varnothing 60$ x $\varnothing 31,75$ x 10	
350011404	Spacer ring $\varnothing 60$ x $\varnothing 31,75$ x 4	
350030060	Lock washer $\varnothing 60$ x $\varnothing 32$ x 1,8	
350020066	Clamping nut $\varnothing 60$ x 6 x M32 x 1,5 PC45	
350020022	*Clamping nut with balancing option $\varnothing 60$ x 9 M32 x 1,5 PC39	

Zaro HSK50 // Shaft $\varnothing 20$ mm // RS $\varnothing 35$ mm

Fitted to Zaro tool grinding machines with ring set $\varnothing 35$ mm

GWA HSK50 // $\varnothing 20$ mm // RS $\varnothing 35$ mm

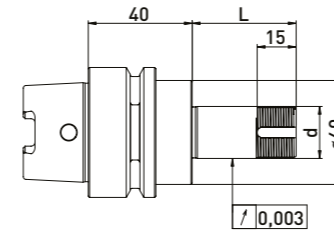
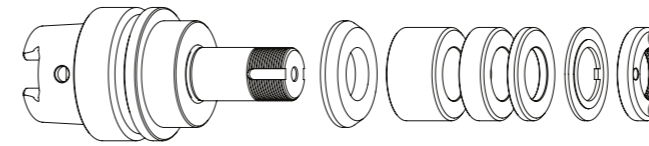

Delivered equipped:
Reducing washer, ring set $\varnothing 35$ mm, lock washer and clamping nut

GWA HSK50 // $\varnothing 20$ mm // without RS

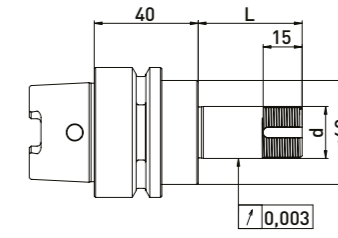
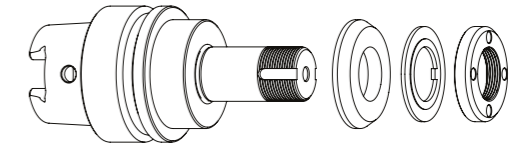

Delivered equipped:
Reducing washer, lock washer and clamping nut

Ring set $\varnothing 35$ mm

Order No.	HSK	d	L	B20	B10	B4
300112512	HSK50	20	40	-	1	3
300112522	HSK50	20	60	1	1	3
300112532	HSK50	20	75	1	2	4
300112542	HSK50	20	85	2	1	4
300112552	HSK50	20	100	2	3	3

Order No.	HSK	d	L
300112511	HSK50	20	40
300112521	HSK50	20	60
300112531	HSK50	20	75
300112541	HSK50	20	85
300112551	HSK50	20	100

Accessories Zaro grinding wheel adapter HSK50 // Shaft $\varnothing 20$ mm // Ring set $\varnothing 35$ mm

Order No.	Name	
350050010	Universal assembly device $\varnothing 50$	
350040010	Clamping nut wrench PC27 for $\varnothing 20$	
350040011	Clamping nut wrench PC27 for $\varnothing 20$	
350040040	*Clamping nut wrench PC29 for $\varnothing 20$ for clamping nut with blancing option	
350040041	*Clamping nut wrench PC29 for $\varnothing 20$	
350020081	*Balancing weight pair for clamping nut $\varnothing 35$ // 40gmm	

Order No.	Name	
350012020	Spacer ring $\varnothing 35$ x $\varnothing 20$ x 20	
350012010	Spacer ring $\varnothing 35$ x $\varnothing 20$ x 10	
350012004	Spacer ring $\varnothing 35$ x $\varnothing 20$ x 4	
350015001	Reducing washer $\varnothing 50$ x $\varnothing 35$ x $\varnothing 20$ x 6	
350030020	Lock washer $\varnothing 35$ x $\varnothing 20$ x 2	
350020030	Clamping nut $\varnothing 35$ x 6 M20 x 1 PC27	
350020080	*Clamping nut with balancing option $\varnothing 35$ x $\varnothing 40$ x 8 x M20 x 1 PC29	
350015005	Support washer $\varnothing 35$ x $\varnothing 60$ x $\varnothing 20$ x 6	

Zaro HSK50 // Shaft $\varnothing 20$ mm // RS $\varnothing 50$ mm

Fitted to Zaro tool grinding machines with ring set $\varnothing 50$ mm

GWA HSK50 // $\varnothing 20$ mm // RS $\varnothing 50$ mm

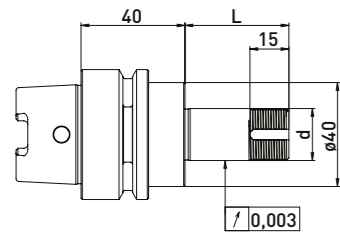
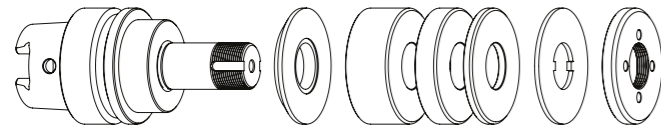

GWA HSK50 // $\varnothing 20$ mm // without RS

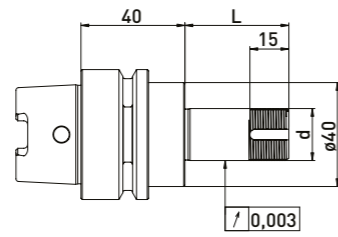
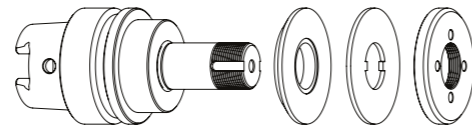

Delivered equipped:

Reducing washer, ring set $\varnothing 50$ mm, lock washer and clamping nut

Delivered equipped:

Reducing washer, lock washer and clamping nut

Order No.	HSK	d	L	Ring set $\varnothing 50$ mm		
				B20	B10	B4
300112012	HSK50	20	40	-	1	3
300112022	HSK50	20	60	1	1	3
300112032	HSK50	20	75	1	2	4
300112042	HSK50	20	85	2	1	4
300112052	HSK50	20	100	2	3	3

Order No.	HSK	d	L
300112011	HSK50	20	40
300112021	HSK50	20	60
300112031	HSK50	20	75
300112041	HSK50	20	85
300112051	HSK50	20	100

Accessories Zaro grinding wheel adapter HSK50 // Shaft $\varnothing 20$ mm // Ring set $\varnothing 50$ mm

Order No.	Name	
350050010	Universal assembly device $\varnothing 50$	
350040010	*Clamping nut wrench PC27 for $\varnothing 20$	
350040011	*Clamping nut wrench PC27 for $\varnothing 20$	
350020021	*Balancing weight pair for clamping nut $\varnothing 50$ // 100gmm	

Order No.	Name	
350011020	Spacer ring $\varnothing 50 \times \varnothing 20 \times 20$	
350011010	Spacer ring $\varnothing 50 \times \varnothing 20 \times 10$	
350011004	Spacer ring $\varnothing 50 \times \varnothing 20 \times 4$	
350015002	Reducing washer $\varnothing 40 \times \varnothing 50 \times \varnothing 20 \times 6$	
350030010	Lock washer $\varnothing 50 \times \varnothing 20 \times 2$	
350020060	Clamping nut $\varnothing 50 \times 6 \times M20 \times 1$ PC27	
350020020	*Clamping nut with balancing option $\varnothing 50 \times 8,5 M20 \times 1,0$ PC27	

Adapters for dressing, presetting etc.

Adapter piece for tool grinding machines, dressing machines, presetting devices, balancing machines

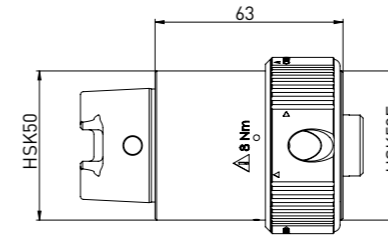

Order No.	Name
350130020	Adapter piece HSK50 on HSK40 A/C/E HSK50 B/D/F

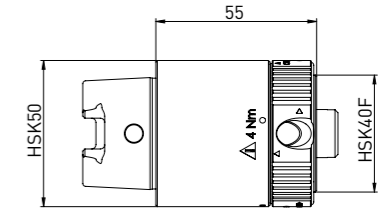

Order No.	Name
350130021	Adapter piece HSK50 on HSK32 A/C/E HSK40 B/D/F

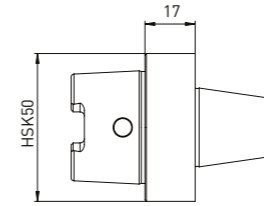

Order No.	Name
350130034	Adapter piece HSK50 on ANCA taper $\varnothing 30$

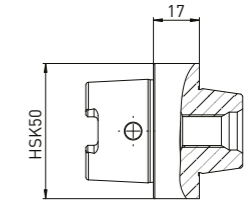

Order No.	Name
350130032	Adapter piece HSK50 on Haas/Walter taper

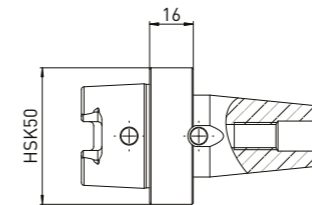

Order No.	Name
350130030	Adapter piece HSK50 on Strausak Fleximat

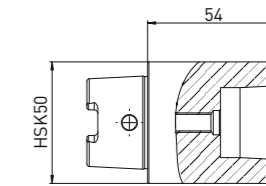

Order No.	Name
350130031	Adapter piece HSK50 on Strausak Promat

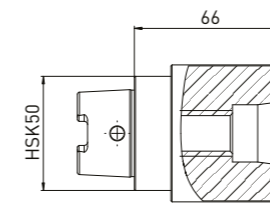

Order No.	Name
350130033	Adapter piece HSK50 on Saacke short taper

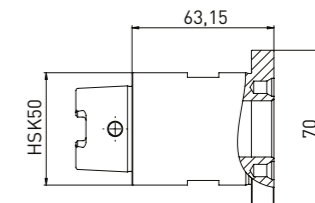

Order No.	Name
350130048	Adapter HSK50 x $\varnothing 25$ on Rollomatic

Adapters fine balanced SK40 and SK50 for tool grinding machines, dressing machines, presetting devices, balancing machines

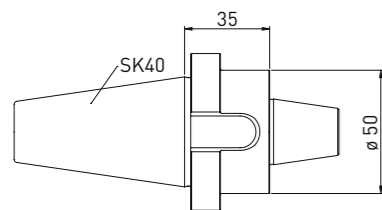

Order No. Name
350130035 Adapter SK40 on ANCA taper ø30

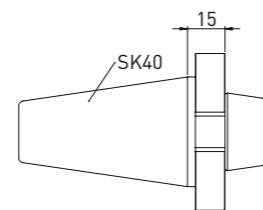

Order No. Name
350130014 Adapter SK40 on Haas/Walter taper

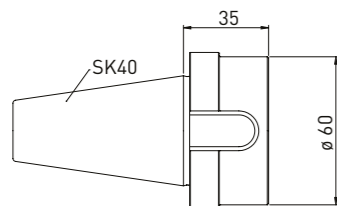

Order No. Name
350130040 Adapter SK40 on Saacke short taper

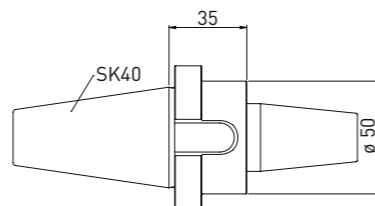

Order No. Name
350130043 Adapter SK40 on Strausak Fleximat

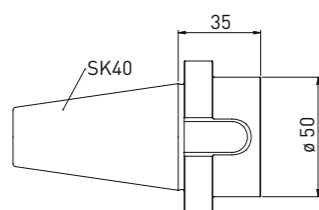

Order No. Name
350130042 Adapter SK40 on Strausak Promat

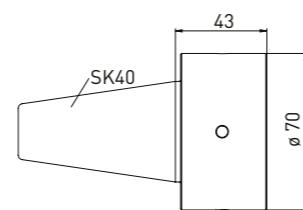

Order No. Name
350130039 Adapter SK40 on Rollomatic ø25

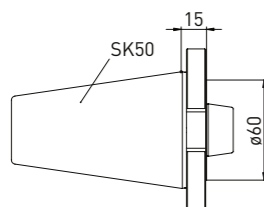

Order No. Name
350130044 Adapter SK50 on Haas/Walter taper L15

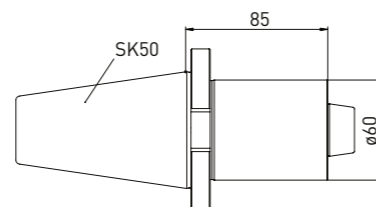

Order No. Name
350130045 Adapter SK50 on Haas/Walter taper L85

Adapter SK40 on HSK

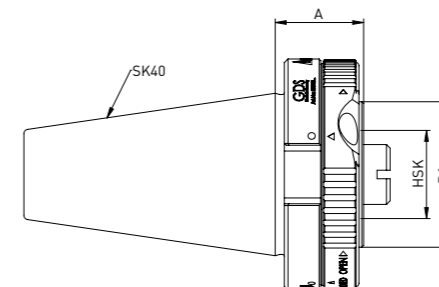

Order No.	A/C/E HSK shape	B/D/F HSK shape	A	D1
350130011	HSK32	HSK40	25	40
350130012	HSK40	HSK50	35	50
350130013	HSK50	HSK63	45	63

Adapter SK50 on HSK

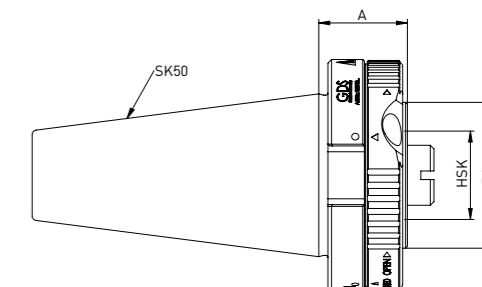

Order No.	A/C/E HSK shape	B/D/F HSK shape	A	D1
350130001	HSK32	HSK40	30	40
350130002	HSK40	HSK50	33	50
350130003	HSK50	HSK63	45	63

Adapters for grinding wheel adapters from $\varnothing 20$ to $\varnothing 10$ // and $\varnothing 20$ to ER16 collet chuck

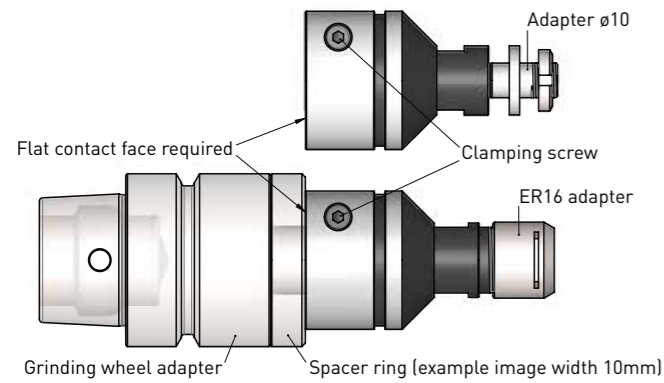

Assembly example

Twist adapter onto M20 x 1 screw and bring to rear to flat contact face.

If needed, lay spacers down first so that the adapter meets the flat contact face.

Subsequently, tighten using spanner flat and secure with clamping screw.

Adapter $\varnothing 20$ on $\varnothing 10$

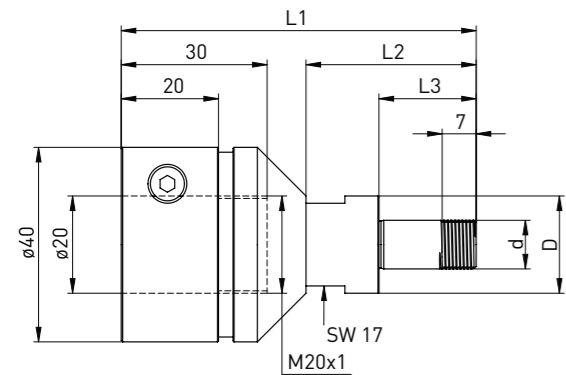

Delivered equipped:
Clamping nut (350020114), Spacer rings 4pc. (350016004)

Order No.	D	d	L1	L2	L3
350130046	20	10	73	35	20

Adapter $\varnothing 20$ on ER16

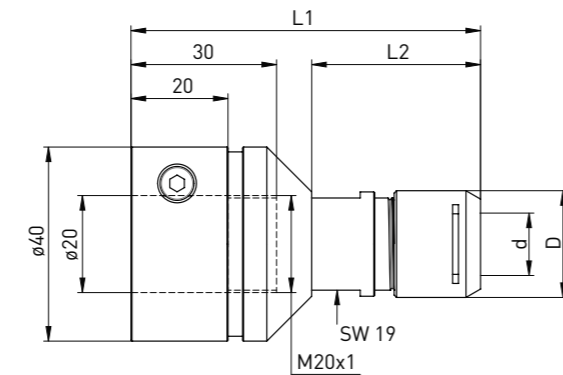

Delivered equipped:
Mini clamping nut Silent ER16 (350020116)

Order No.	D	d	L1	L2
350130047	22	ER16	76	34

Accessories Adapter $\varnothing 20$ on $\varnothing 10$

Order No.	Name - \varnothing
350016004	Spacer ring $\varnothing 20$ x $\varnothing 10$ x 3
350020114	Clamping nut $\varnothing 18$ x 4 - M10 x 0,75
350040050	Hook wrench 16-20 mm

Accessories Adapter $\varnothing 20$ on ER16

Order No.	Name
350125116	Mini clamping nut SILENT ER16
350126116	Clamping wrench for Mini clamping nut SILENT ER16

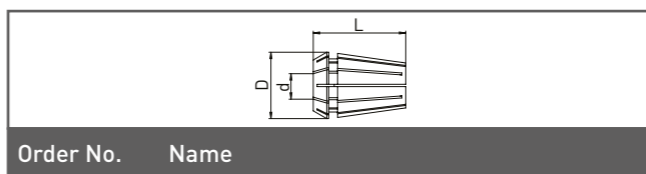

Order No.	Name
3501217**	Collet DIN 6499 ER16 ** $\varnothing 1$ -10mm

**[Please complete the order number with the two-digit number that defines the diameter!] e.g. for $\varnothing 1$ -> last digit 01 (350121701) for $\varnothing 10$ last digit ->10 (350121710)

HSK50 Test and angle dial

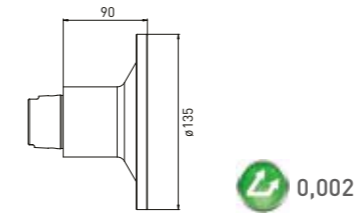

Order No.	Name
350090010	Test and angle dial HSK50

HSK40 Test and angle dial

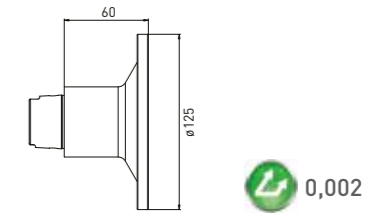

Order No.	Name
350090020	Test and angle dial HSK40

Test and angle dial

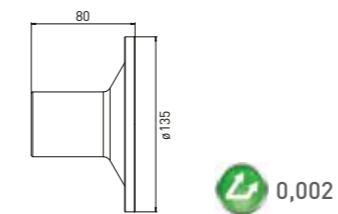

Order No.	Name
350090030	Angle dial Haas/Walter taper 31.75

SK Test mandrel

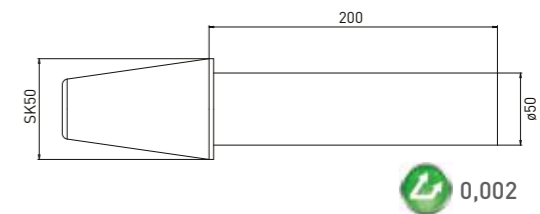

Order No.	Name
350090040	Test mandrel SK50 x $\varnothing 50$ x 200

HSK Test mandrel

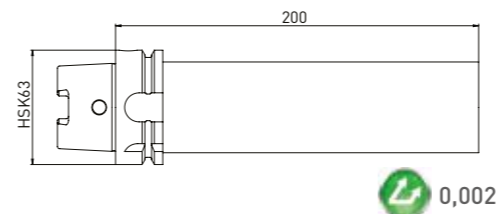

Order No.	Name
350090050	Test mandrel HSK63 x $\varnothing 50$ x 200

HSK Test mandrel

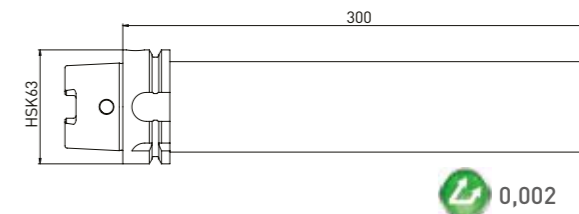

Order No.	Name
350090060	Test mandrel HSK63 x $\varnothing 50$ x 300

Equi'Z balancing accessories for tool grinding machines

Order No.	Name
400006001	Equi'Z Competition to HSK63 or SK40 for Tablet // Notebook // PC
400006004	Equi'Z Competition Stand Alone 1 plane, to HSK63 / SK40 / PSC 5, BMT200-1.OP40
400006005	Equi'Z Competition Stand Alone 1+2 plane, to HSK63 / SK40 / PSC 5, BMT200-2.OP40

Order No.	Name
400006003	Equi'Z Ultimate to HSK100 or SK50 for Tablet // Notebook // PC
400006006	Equi'Z Ultimate Stand Alone 1 plane, to HSK125 / SK50 / PSC 8, BMT200-1.OP100
400006007	Equi'Z Ultimate Stand Alone 1+2 plane, to HSK125 / SK50 / PSC 8, BMT200-2.OP100

For balancing machine:

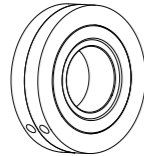

Order No.	Name
350080120	Balancing ring without scale 3-part 80gmm $\phi 60 \times \phi 20 \times 12$
350080130	Balancing ring without scale 3-part 80gmm $\phi 45 \times \phi 20 \times 12$

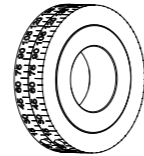

Order No.	Name
350080100	Balancing ring with scale 3-part 80gmm $\phi 60 \times \phi 20 \times 12$
350080110	Balancing ring with scale 3-part 80gmm $\phi 45 \times \phi 20 \times 12$

For grinding wheel adapters:

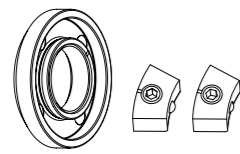

Order No.	Name
350020080	Clamping nut with balancing option $\phi 35 \times \phi 40 \times 8 \times M20 \times 1$ (without weights)
350020081	Balancing weight pair for clamping nut $\phi 35$ 40gmm
350040040	Clamping nut wrench PC29 for $\phi 20$

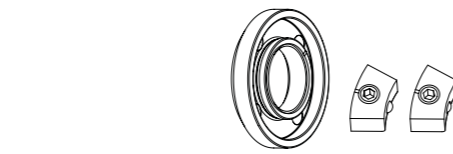

Order No.	Name
350020020	Clamping nut with balancing option $\phi 50 \times 8,5 M20 \times 1,0$ (without weights)
350020021	Balancing weight pair for clamping nut $\phi 50$ 100gmm
350040010	Clamping nut wrench PC 27 for $\phi 20$

Order No.	Name
350020026	Clamping nut with balancing option $\phi 47 \times 12 M31,5 \times 1,5$ (without weights)
350020027	Balancing weight pair for clamping nut $\phi 47$ 70gmm
350040030	Clamping nut wrench PC39 for $\phi 47$

Order No.	Name
350020022	Clamping nut with balancing option $\phi 60 \times 9 M32 \times 1,5$ (without weights)
350020023	Balancing weight pair for clamping nut $\phi 60$ 200gmm
350040030	Clamping nut wrench PC39 for $\phi 47$

Accessories Standard and Competition:

Item No.	Name
350080221	Equi'Z Adapter Perfect Arbor Standard // Competition
350080250	Equi'Z Adapter HSK63-A Standard // Competition
350080252	Equi'Z Adapter HSK63-F Standard // Competition
350080260	Equi'Z Adapter HSK50-A Standard // Competition
350080262	Equi'Z Adapter HSK50-F Standard // Competition
350080270	Equi'Z Adapter HSK40-A Standard // Competition
350080272	Equi'Z Adapter HSK40-F Standard // Competition
350080280	Equi'Z Adapter HSK32-F Standard // Competition
350080285	Equi'Z Adapter HSK25-A Standard // Competition
350080286	Equi'Z Adapter HSK32-A Standard // Competition
350080290	Equi'Z Adapter SK30-A Standard // Competition
350080300	Equi'Z Adapter SK40-A Standard // Competition
350080399	Equi'Z Adapter BT30/ANSI Standard // Competition
350080400	Equi'Z Adapter BT30/PT45 Standard // Competition
350080401	Equi'Z Adapter BT30/PT60 Standard // Competition
350080402	Equi'Z Adapter BT40/PT15 Standard // Competition
350080403	Equi'Z Adapter BT40/PT30 Standard // Competition
350080404	Equi'Z Adapter BT40/PT45 Standard // Competition
350080405	Equi'Z Adapter BT40/PT60 Standard // Competition
350080406	Equi'Z Adapter BT40/PT75 Standard // Competition
350080407	Equi'Z Adapter BT40/PT90 Standard // Competition

Accessories Power and Ultimate:

Item No.	Name
350080222	Equi'Z Adapter Perfect Arbor Power // Ultimate
350080251	Equi'Z Adapter HSK63-A Power // Ultimate
350080255	Equi'Z Adapter HSK80-A Power // Ultimate
350080256	Equi'Z Adapter HSK100-A Power // Ultimate
350080263	Equi'Z Adapter HSK50-A Power // Ultimate
350080271	Equi'Z Adapter HSK40-A Power // Ultimate
350080287	Equi'Z Adapter HSK32-A Power // Ultimate
350080310	Equi'Z Adapter SK50-A Power // Ultimate
350080311	Equi'Z Adapter SK40-A Power // Ultimate
350080312	Equi'Z Adapter SK30-A Power // Ultimate
350080410	Equi'Z Adapter BT30/PT30 Power // Ultimate
350080411	Equi'Z Adapter BT30/PT45 Power // Ultimate
350080413	Equi'Z Adapter BT40/PT30 Power // Ultimate
350080414	Equi'Z Adapter BT40/PT45 Power // Ultimate
350080415	Equi'Z Adapter BT40/PT90 Power // Ultimate
350080416	Equi'Z Adapter BT50/PT30 Power // Ultimate
350080417	Equi'Z Adapter BT50/PT45 Power // Ultimate
350080418	Equi'Z Adapter BT50/PT90 Power // Ultimate

Accessories Standard, Competition, Power and Ultimate:

Item No.	Name
400006075	Equi'Z tablet stand
400006076	Equi'Z tablet tray

Accessories for our grinding wheel adapters are to be found on each product page.

Universal assembly device $\varnothing 50$ fits a multitude of grinding wheel adapters.

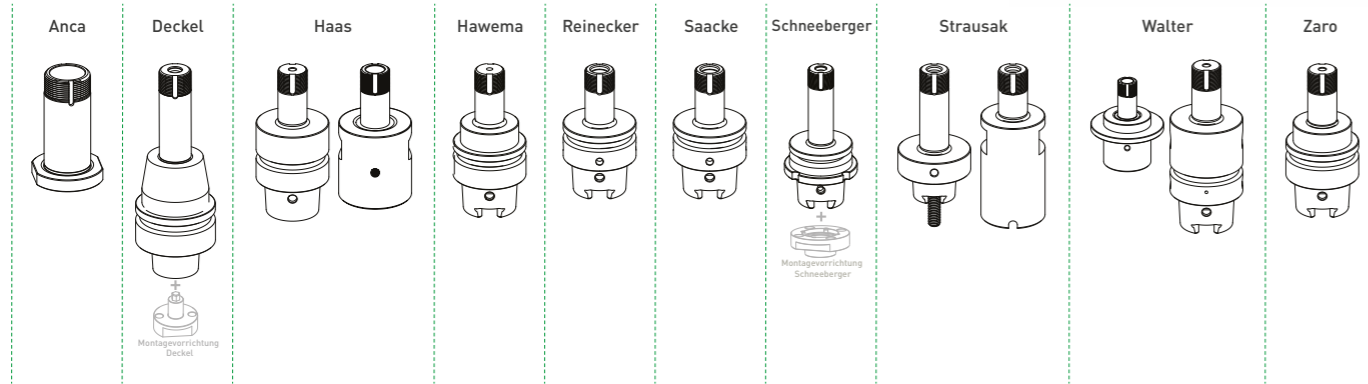

Clamping nut wrenches in various pitch circles.



Clamping nuts with balancing option and suitable balancing weights.



Our certified partners **take care of you**, where we can't be in person, providing optimal support and answers to your questions.



Local GDS partners offer the complete line of original GDS grinding wheel adapters as well as clamping and balancing solutions for tool grinding.

From consulting to order processing, please contact your local GDS partners.

GDS - the precision makers



D- PLZ 0 - 6
GDS Präzisionszerspanungs GmbH
 Endelbergstraße 8
 72131 Ofterdingen
 Tel: +49 (0) 74 73 - 27 26 72
 Fax: +49 (0) 74 73 - 27 26 49
 E-Mail: info@gds-praezision.de
 Web: www.gds-praezision.de

D- PLZ 5 + 7
Fischer Präzisionswerkzeug-Maschinen GmbH & Co. KG
 Burghaldenstraße 2
 71065 Sindelfingen
 Tel: +49 (0) 70 31 - 81 10 - 25
 Fax: +49 (0) 70 31 - 81 10 - 27
 E-Mail: info@hf-fischer.de
 Web: www.hf-fischer.de

D- PLZ 8 + 9
Balletshofer Schleiftechnik
 Am Geiselbach 28
 86637 Zusamaltheim
 Mobil: +49 (0) 1 70 - 3 44 54 74
 Fax: +49 (0) 82 96 - 90 98 96
 E-Mail: info@balletshofer.com
 Web: www.balletshofer.com



AUSTRIA

plan:b4u GmbH
Colmarplatz 1 / Top XXIII
7000 Eisenstadt Austria
Tel: +43 664 127 3039
E-Mail: info@planb4u.com
Web: www.planb4u.com

BELARUS

AWM Precision GmbH
Genshagener Straße 27
14974 Ludwigsfelde Germany
Tel: +49 (0) 33 78 - 5 18 63 67
E-Mail: arnold@awm-precision.com
Web: www.awm-precision.com

BELGIUM

oelheld technologies SAS
innovative fluid technology
Technopôle de Forbach-Sud
140, Avenue Jean-Eric Bousch
57600 Oeting France
Tel: +33 (0) 387-90 42 14
Fax: +33 (0) 387-84 66 91
E-Mail: martin.gundelach@oelheld.de
Web: www.oelheld.com

CZECH/SLOVAKIA

Dr. MÜLLER DIAMANTMETALL AG
Leptosenweg 34
82362 Weilheim i. Ob. Germany
Tel: +49 (0) 881 - 90 11 55-0
Fax: +49 (0) 881 - 90 11 55-100
E-Mail: vertrieb@muedia.de
Web: www.muedia.de

DENMARK

M-Tech ApS
Holkebjergvej 75
5250 Odense SV Dänemark
Tel: +45 3034 1415
E-Mail: m-tech@jakobsen.mail.dk

ESTONIA

AWM Precision GmbH
Genshagener Straße 27
14974 Ludwigsfelde Germany
Tel: +49 (0) 33 78 - 5 18 63 67
E-Mail: arnold@awm-precision.com
Web: www.awm-precision.com

FINLAND

Diamack Oy
Asentajankatu 9 C
48770 Kotka Finland
Tel: +358 5 - 21 41 20
Fax: +358 5 - 21 41 70
E-Mail: diamack@diamack.fi
Web: www.diamack.fi

FRANCE

oelheld technologies SAS
innovative fluid technology
Technopôle de Forbach-Sud
140, Avenue Jean-Eric Bousch
57600 Oeting France
Tel: +33 (0) 387-90 42 14
Fax: +33 (0) 387-84 66 91
E-Mail: martin.gundelach@oelheld.de
Web: www.oelheld.com

HUNGARY

Szerszám Technika Kft.
Dűlő u. 4.
1225 Budapest Hungary
Tel: +36 1 287 82 76
Fax: +36 1 287 82 77
E-Mail: info@szerszamtechnika.hu
Web: www.szerszamtechnika.hu

IRELAND

oelheld UK Ltd
Unit 16, Colomendy Business Park,
Erw Las, Denbigh LL16 5TA, UK
Tel: +44 (0)1745 814 777
Fax: +44 (0)1745 813 222
E-Mail: sales@oelheld.co.uk
Web: www.oelheld.co.uk

ITALY

Utensileria FAVRIN SrL
Via Per Cabiante 79
22066 Mariano Comense Italy
Tel: +39 (0) 31 - 74 72 00
Fax: +39 (0) 31 - 75 12 22
E-Mail: utensileria-mariano@favrin.it
Web: www.utensileria-favrin.it

LATVIA

AWM Precision GmbH
Genshagener Straße 27
14974 Ludwigsfelde Germany
Tel: +49 (0) 33 78 - 5 18 63 67
E-Mail: arnold@awm-precision.com
Web: www.awm-precision.com

LITHUANIA

AWM Precision GmbH
Genshagener Straße 27
14974 Ludwigsfelde Germany
Tel: +49 (0) 33 78 - 5 18 63 67
E-Mail: arnold@awm-precision.com
Web: www.awm-precision.com

LUXEMBOURG

oelheld technologies SAS
innovative fluid technology
Technopôle de Forbach-Sud
140, Avenue Jean-Eric Bousch
57600 Oeting France
Tel: +33 (0) 387-90 42 14
Fax: +33 (0) 387-84 66 91
E-Mail: martin.gundelach@oelheld.de
Web: www.oelheld.com

NETHERLANDS

oelheld technologies SAS
innovative fluid technology
Technopôle de Forbach-Sud
140, Avenue Jean-Eric Bousch
57600 Oeting France
Tel: +33 (0) 387-90 42 14
Fax: +33 (0) 387-84 66 91
E-Mail: martin.gundelach@oelheld.de
Web: www.oelheld.com

POLAND

Vollmer Polska sp z o.o.
ul.Handlowa 11
41-807 Zabrze Poland
Tel: +48 32 733 08 69
E-Mail: info-pl@vollmer-group.com
Web: www.vollmer-group.com

PORTUGAL // SPAIN

Procut
Parque Industrial Cruzeiro
Rua Nossa Senhora da Ajuda 150
4815-364 Moreira de Conegos Portugal
Tel: +351 253 56 12 11
Fax: +351 253 56 39 49
E-Mail: info@procut.pt
Web: www.procut.pt

SWEDEN // NORWAY

Ehn & Land AB
Bultvägen 4
553 02 Jönköping Sweden
Tel: +46 86 35 34-50
Fax: +46 86 35 34-70
E-Mail: info@ehnland.se
Web: www.ehnland.se

SWITZERLAND

Ziegler + Cie AG
Industriestraße 12
8404 Winterthur Switzerland
Tel: +41 (0) 52 234 20 20
Fax: +41 (0) 52 234 20 10
E-Mail: info@zieglerag.ch
Web: www.zieglerag.ch

UKRAINE

AWM Precision GmbH
Genshagener Straße 27
14974 Ludwigsfelde Germany
Tel: +49 (0) 33 78 - 5 18 63 67
E-Mail: arnold@awm-precision.com
Web: www.awm-precision.com

UNITED KINGDOM

oelheld UK Ltd
Unit 16, Colomendy Business Park,
Erw Las, Denbigh LL16 5TA, UK
Tel: +44 (0)1745 814 777
Fax: +44 (0)1745 813 222
E-Mail: sales@oelheld.co.uk
Web: www.oelheld.co.uk



CHINA

HERZOG CHINA CO.,LTD.
4/F, No.3232 Beimen Road,
Kunshan, Jiangsu 215316 China
Tel: +86-512-55 19 05 78
Fax: +86-512-55 19 05 76
E-Mail: dezhu@herzog-china.com
Web: www.herzog-china.com

Changzhou Technology Service Center

West Street 255#, Xixiashu Town,
Xinbei District, Changzhou City,
Jiangsu Province, China
Tel: +86-519-83 85 09 55
E-Mail: dezhu@herzog-china.com

South China Technology Service Center

FuYuan Business Center 206#, 1# 13th Alley,
MaiYuan Road, XinAn Community, ChangAn Town,
DongGuan City, GuangDong Province China
Tel: +86-769-81 88 99 62
E-Mail: dezhu@herzog-china.com

INDIA

Herzog India Company
Rahul K. Sapkal N9, R27, 159,
Pratap Gad Nagar, Cidco, Aurangabad,
Maharashtra, India 431003
Tel: +91-8669667550
E-Mail: herzogindia@gmail.com

IRAN

plan:b4u GmbH
Colmarplatz 1 / Top XXIII
7000 Eisenstadt Austria
Tel: +43 664 127 3039
E-Mail: info@planb4u.com
Web: www.planb4u.com

IRAQ

plan:b4u GmbH
Colmarplatz 1 / Top XXIII
7000 Eisenstadt Austria
Tel: +43 664 127 3039
E-Mail: info@planb4u.com
Web: www.planb4u.com

ISRAEL

De-Paz Machinery
CNC machines & Accessories
Menachem Begin 80 Blvd
Afula. 1871356 Israel
Tel: +972-54-421 48 72
E-Mail: zion@de-paz.com
Web: www.de-paz.com

JAPAN

Vollmer Japan Corp.
Haraichi 283-1
362-0021, Ageo-Shi
Saitama-Ken Japan
Tel: +81-48 795 4110
Fax: +81-48 795 4112
E-Mail: INFO-JAPAN@VOLLMER-GROUP.COM

KAZAKHSTAN

AWM Precision GmbH
Genshagener Straße 27
14974 Ludwigsfelde Germany
Tel: +49 (0) 33 78 - 5 18 63 67
E-Mail: arnold@awm-precision.com
Web: www.awm-precision.com

KATAR

plan:b4u GmbH
Colmarplatz 1 / Top XXIII
7000 Eisenstadt Austria
Tel: +43 664 127 3039
E-Mail: info@planb4u.com
Web: www.planb4u.com

KOREA

Central Technology Co. Ltd
D-1311, Gwangmyeong Techno Park,
Haanro 60, Gwangmyeong-Si,
Gyeonggi-Do, 423-050 Korea
Tel: +82-2-897-0945
Fax: +82-2-897-0943
E-Mail: ycr@centraltech.co.kr
Web: www.centraltech.co.kr

KUWAIT

plan:b4u GmbH
Colmarplatz 1 / Top XXIII
7000 Eisenstadt Austria
Tel: +43 664 127 3039
E-Mail: info@planb4u.com
Web: www.planb4u.com

LAOS

VOLLMER Asia Pacific Co., Ltd.
20th Floor, SJ Infinite One Business Complex
Unit 2001-2005 349 Vibhavadi-Rangsit Road,
Chompol Chatuchak, Bangkok,
10900, Thailand
Tel: +66 (0)20183536
E-Mail: Info-VOAP@vollmer-group.com

MYANMAR

VOLLMER Asia Pacific Co., Ltd.
20th Floor, SJ Infinite One Business Complex
Unit 2001-2005 349 Vibhavadi-Rangsit Road,
Chompol Chatuchak, Bangkok,
10900, Thailand
Tel: +66 (0)20183536
E-Mail: Info-VOAP@vollmer-group.com

OMAN

plan:b4u GmbH
Colmarplatz 1 / Top XXIII
7000 Eisenstadt Austria
Tel: +43 664 127 3039
E-Mail: info@planb4u.com
Web: www.planb4u.com

PAZIFIK

(Indonesia, Malaysia, Singapore)
VOLLMER Asia Pacific Co., Ltd.
20th Floor, SJ Infinite One Business Complex
Unit 2001-2005
349 Vibhavadi-Rangsit Road, Chompol
Chatuchak, Bangkok, 10900 Thailand
Tel: +66 (0)20183536
E-Mail: Info-VOAP@vollmer-group.com

PHILLIPINES

VOLLMER Asia Pacific Co., Ltd.
20th Floor, SJ Infinite One Business Complex
Unit 2001-2005 349 Vibhavadi-Rangsit Road,
Chompol Chatuchak, Bangkok,
10900, Thailand
Tel: +66 (0)20183536
E-Mail: Info-VOAP@vollmer-group.com

RUSSIA

AWM Precision GmbH
Genshagener Straße 27
14974 Ludwigsfelde Germany
Tel: +49 (0) 33 78 - 5 18 63 67
E-Mail: arnold@awm-precision.com
Web: www.awm-precision.com

SAUDI-ARABIA

plan:b4u GmbH
Colmarplatz 1 / Top XXIII
7000 Eisenstadt Austria
Tel: +43 664 127 3039
E-Mail: info@planb4u.com
Web: www.planb4u.com

TAIWAN

HERZOG Taiwan Co., Ltd.
10F, No.70 Gongyequ 1st Rd., Situn Dist.
Taichung City 40766 Taiwan (R.O.C.)
Tel: +886-4-23 55-33 88
Fax: +886-4-23 55-22 99
E-Mail: deluca@herzog-taiwan.com.tw
Web: www.costa.com.tw

THAILAND

VOLLMER Asia Pacific Co., Ltd.
20th Floor, SJ Infinite One Business Complex
Unit 2001-2005
349 Vibhavadi-Rangsit Road, Chompol
Chatuchak, Bangkok, 10900 Thailand

TURKEY

GDS Turkiye
Yusuf Değirmenci Bahçeşehir 2.Kısım Mah.
Mercedes Blv. No:24 BBC Dükkan No:50
Başakşehir/Istanbul
Tel: +90 544 821 35 29
E-Mail: yusuf@gds-turkiye.com
Web: www.gds-turkiye.com

UNITED ARAB EMIRATES

plan:b4u GmbH
Colmarplatz 1 / Top XXIII
7000 Eisenstadt Austria
Tel: +43 664 127 3039
E-Mail: info@planb4u.com
Web: www.planb4u.com

VIETNAM

VOLLMER Asia Pacific Co., Ltd.
20th Floor, SJ Infinite One Business Complex
Unit 2001-2005 349 Vibhavadi-Rangsit Road,
Chompol Chatuchak, Bangkok,
10900, Thailand
Tel: +66 (0)20183536
E-Mail: Info-VOAP@vollmer-group.com



ALGERIA

oelheld technologies SAS
 innovative fluid technology
 Technopôle de Forbach-Sud
 140, Avenue Jean-Eric Bousch
 57600 Oeting France
 Tel: +33 (0) 387-90 42 14
 Fax: +33 (0) 387-84 66 91
 E-Mail: martin.gundelach@oelheld.de
 Web: www.oelheld.com

AUSTRALIA

Camco Cutting Tools Int'l Pty. Ltd.
 1/25 Mareno Rd., P.O. Box 1575,
 Tullamarine, Victoria, 3043 Australia
 Tel: +61 (0)3 8336 1500
 Fax: +61 (0)3 8336 1499
 Mob: +61 (0)413 126 868
 E-Mail: sales@camcointl.com

CANADA

Toolroom Solutions Inc.
 Ed Sinkora
 8824 Old Block House Ln
 22551 Spotsylvania USA
 Tel: +1 540 9 40 - 59 77
 E-Mail: ed@toolroom.solutions

MOROCCO

oelheld technologies SAS
 innovative fluid technology
 Technopôle de Forbach-Sud
 140, Avenue Jean-Eric Bousch
 57600 Oeting France
 Tel: +33 (0) 387-90 42 14
 Fax: +33 (0) 387-84 66 91
 E-Mail: martin.gundelach@oelheld.de
 Web: www.oelheld.com

MEXICO

Toolroom Solutions Inc.
 Ed Sinkora
 8824 Old Block House Ln
 22551 Spotsylvania USA
 Tel: +1 540 9 40 - 59 77
 E-Mail: ed@toolroom.solutions

TUNISIA

oelheld technologies SAS
 innovative fluid technology
 Technopôle de Forbach-Sud
 140, Avenue Jean-Eric Bousch
 57600 Oeting France
 Tel: +33 (0) 387-90 42 14
 Fax: +33 (0) 387-84 66 91
 E-Mail: martin.gundelach@oelheld.de
 Web: www.oelheld.com

USA

Toolroom Solutions Inc.
 Ed Sinkora
 8824 Old Block House Ln
 22551 Spotsylvania USA
 Tel: +1 540 9 40 - 59 77
 E-Mail: ed@toolroom.solutions

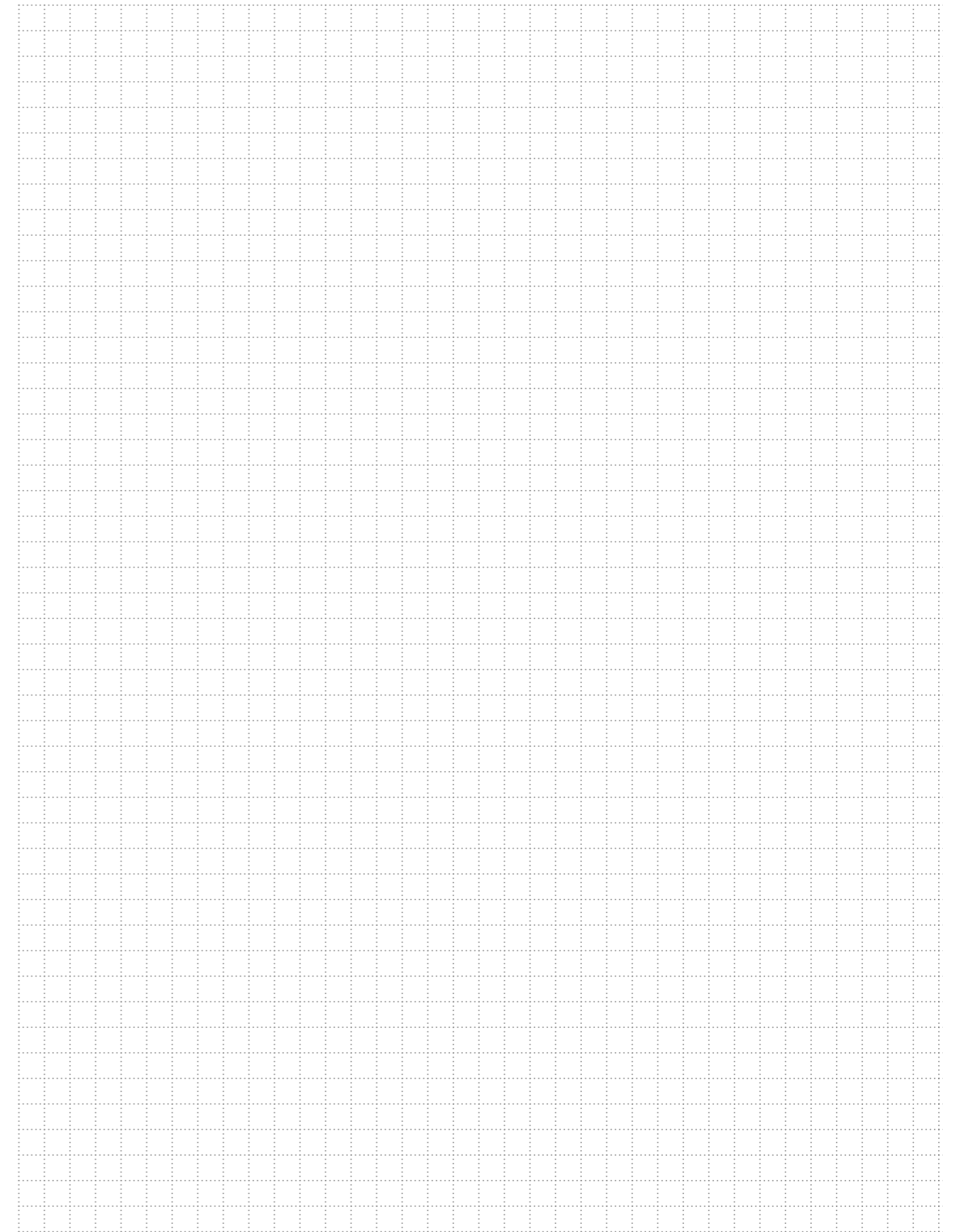
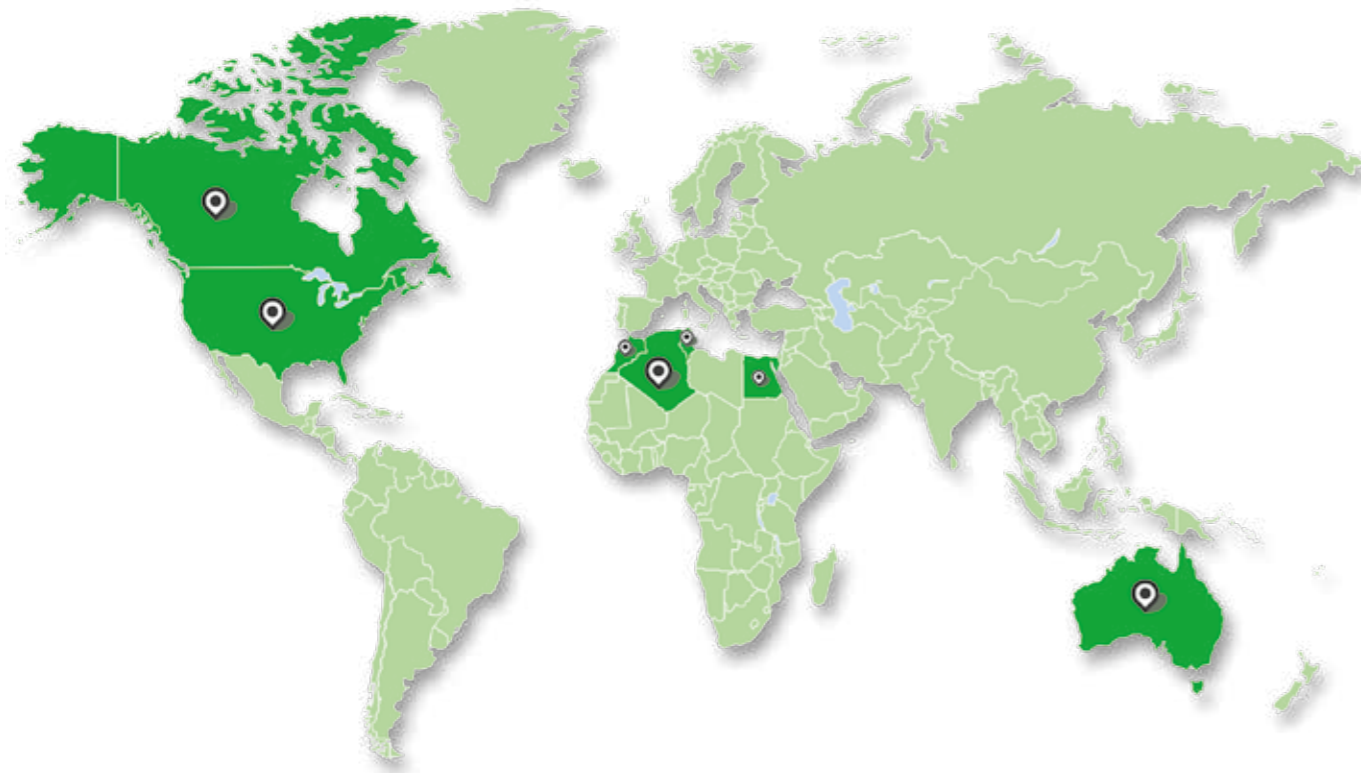

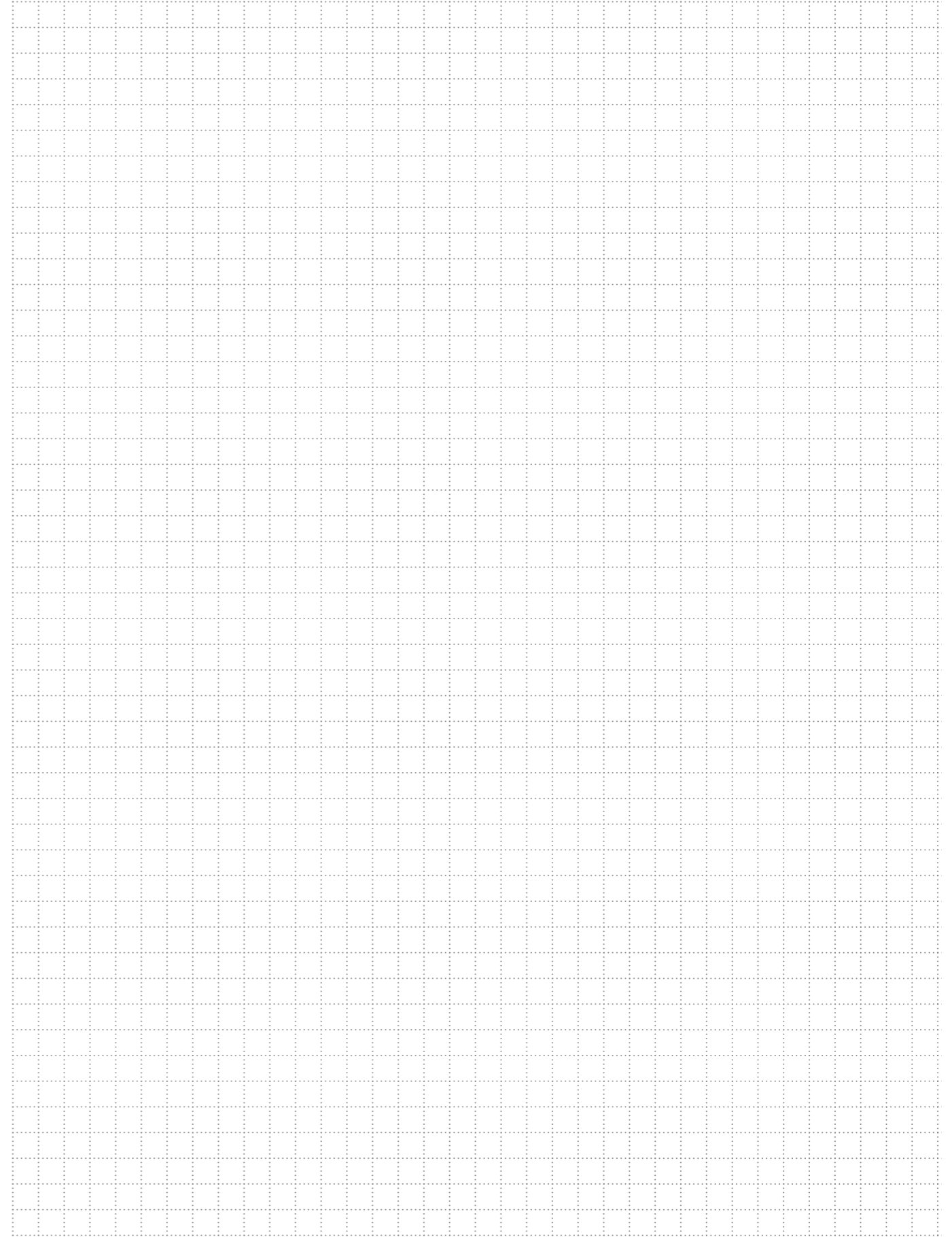
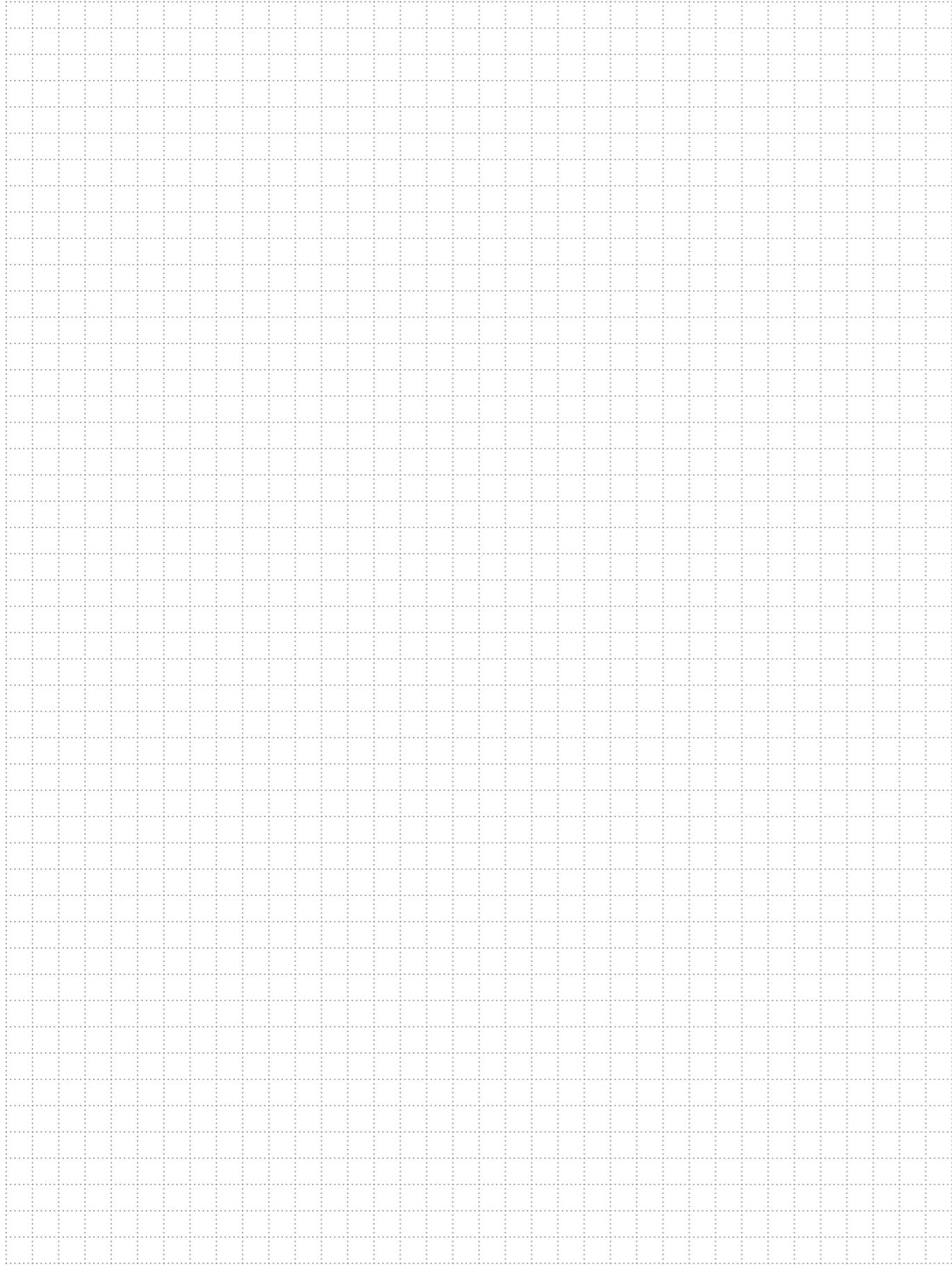

REVOLUTION IN TOOLGRINDING

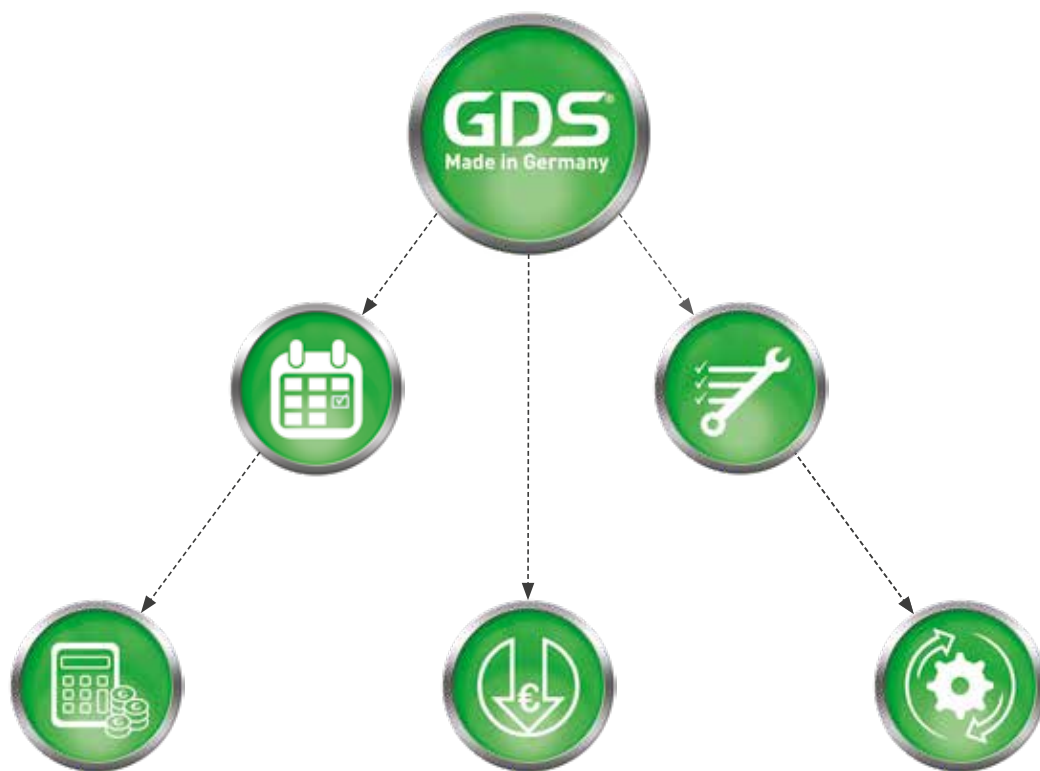

GDS Präzisionszerspanungs GmbH // Endelbergstraße 8 // 72131 Oftringen

Telefon: + 49 (0) 74 73 - 27 26 72
Telefax: + 49 (0) 74 73 - 27 26 49

Email: info@gds-precision.de
Web: www.gds-precision.de

GDS[®]
Made in Germany