

# Rollomatic $\varnothing 25$ mm // Shaft $\varnothing 20$ mm // RS $\varnothing 50$ mm

For Rollomatic tool grinding machines with ring set  $\varnothing 50$  mm

GWA  $\varnothing 25$  mm //  $\varnothing 20$  mm // RS  $\varnothing 50$  mm

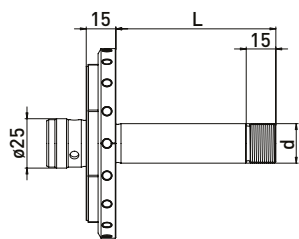
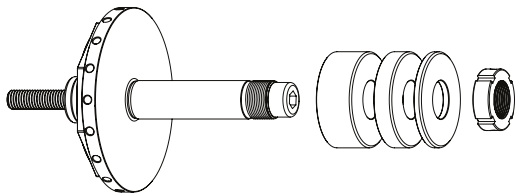

Delivered equipped:

Ring set  $\varnothing 50$  mm, M10 clamping screw and clamping nut

Ring set  $\varnothing 50$  mm

Order No.	d	L	B 20	B 10	B 4
300150412	20	50	-	2	4
300150422	20	81	1	3	4

## Accessories Rollomatic grinding wheel adapter $\varnothing 25$ mm // Shaft $\varnothing 20$ mm // RS $\varnothing 50$ mm

Order No.	Name
350040051	Hook wrench 30 - 32 mm



Order No.	Name
350011520	Spacer ring Rollomatic $\varnothing 50$ x $\varnothing 20$ x 20
350011510	Spacer ring Rollomatic $\varnothing 50$ x $\varnothing 20$ x 10
350011504	Spacer ring Rollomatic $\varnothing 50$ x $\varnothing 20$ x 4
350020120	Clamping nut MRR20x1 M20 x 1 - $\varnothing 32$ x 10
350015003	Support washer $\varnothing 50$ x $\varnothing 75$ x $\varnothing 20$ x 6



# Rollomatic $\varnothing 25$ mm // Shaft $\varnothing 31,75$ mm (1 $\frac{1}{4}$ )

For Rollomatic tool grinding machines

GWA  $\varnothing 25$  mm //  $\varnothing 31,75$  mm (1 $\frac{1}{4}$ )

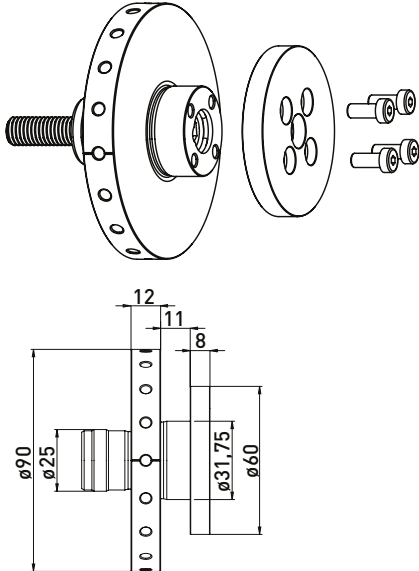

#### Delivered equipped:

Clamping flange, 4pc. M5x12 cylinder screws and M10 clamping screw

Order No.	Name
300150510	Grinding wheel adapter Rollomatic $\varnothing 31,75$ x 11

# Rollomatic $\varnothing 25$ mm // Shaft $\varnothing 31,75$ mm ( $1\frac{1}{4}$ ) // RS $\varnothing 60$ mm

For Rollomatic tool grinding machines with ring set  $\varnothing 60$  mm

GWA  $\varnothing 25$  mm //  $\varnothing 31,75$  mm ( $1\frac{1}{4}$ ) // RS  $\varnothing 60$  mm

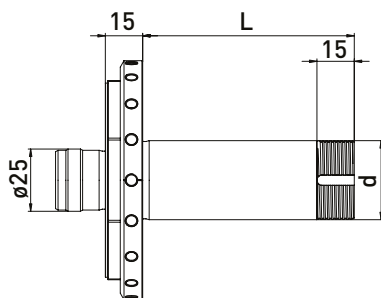
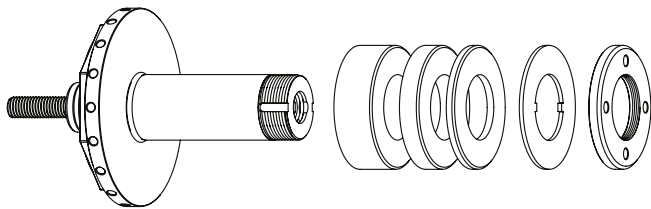







## Delivered equipped:

Ring set  $\varnothing 60$  mm, M10 clamping screw, lock washer and clamping nut

Order No.	d	L	Ring set $\varnothing 60$ mm		
			B 20	B 10	B 4
300150212	31,75	50	-	2	4
300150222	31,75	85	2	2	3
300150232	31,75	115	3	3	3

## Accessories Rollomatic grinding wheel adapter $\varnothing 25$ mm // $\varnothing 31,75$ mm ( $1\frac{1}{4}$ ) // RS $\varnothing 60$ mm

Order No.	Name
350040020	Clamping nut wrench PC45 for $\varnothing 32$ 

Order No.	Name
350011620	Spacer ring Rollomatic $\varnothing 60 \times \varnothing 31,75 \times 20$ 
350011610	Spacer ring Rollomatic $\varnothing 60 \times \varnothing 31,75 \times 10$ 
350011604	Spacer ring Rollomatic $\varnothing 60 \times \varnothing 31,75 \times 4$ 
350030060	Lock washer $\varnothing 60 \times \varnothing 32 \times 1,8$ 
350020066	Clamping nut $\varnothing 60 \times 6 \times M32 \times 1,5$ PC45 

# Rollomatic $\varnothing 25$ mm // Shaft $\varnothing 32$ // RS $\varnothing 60$ mm

For Rollomatic tool grinding machines with ring set  $\varnothing 60$  mm

GWA  $\varnothing 25$  mm //  $\varnothing 32$  mm // RS  $\varnothing 60$  mm

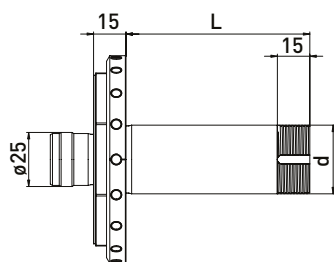
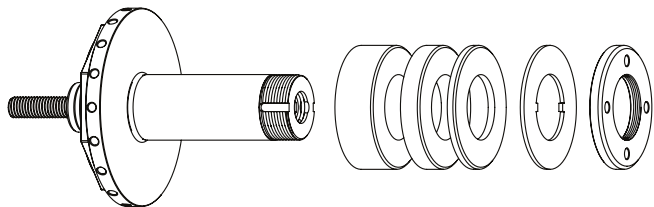







### Delivered equipped:

Ring set  $\varnothing 60$  mm, M10 clamping screw lock washer and clamping nut

Order No.	d	L	Ring set $\varnothing 60$ mm		
			B 20	B 10	B 4
300150312	32	50	-	2	4
300150322	32	85	2	2	3
300150332	32	115	3	3	3

## Accessories Rollomatic grinding wheel adapter $\varnothing 25$ mm // Shaft $\varnothing 32$ mm // RS $\varnothing 60$ mm

Order No.	Name
350040020	Clamping nut wrench PC45 for $\varnothing 32$ 

Order No.	Name
350011320	Spacer ring $\varnothing 60 \times \varnothing 32 \times 20$ 
350011310	Spacer ring $\varnothing 60 \times \varnothing 32 \times 10$ 
350011304	Spacer ring $\varnothing 60 \times \varnothing 32 \times 4$ 
350030060	Lock washer $\varnothing 60 \times \varnothing 32 \times 1,8$ 
350020066	Clamping nut $\varnothing 60 \times 6 \times M32 \times 1,5$ PC45 

\*related items

# Rollomatic $\varnothing 25$ mm // stepped Shaft $\varnothing 25$ , $\varnothing 35$ , $\varnothing 50$ mm

For Rollomatic tool grinding machines

## GWA $\varnothing 25$ mm // stepped Shaft

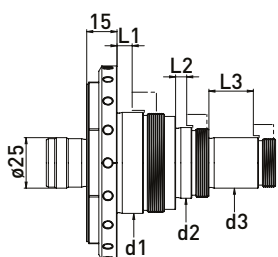
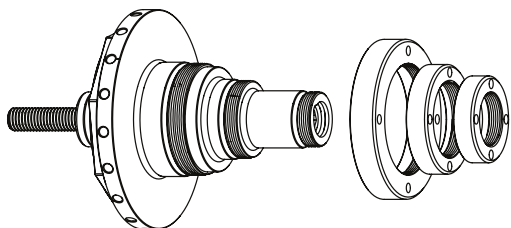

### Delivered equipped:

per 1 piece clamping nut  $\varnothing 38$  (350020110),  $\varnothing 48$  (350020111),  $\varnothing 70$  (350020113) and M10 clamping screw

Order No.	L1	L2	L3	d1	d2	d3
300150111	11,5	5,5	5,5	50	35	25
300150121	7,5	5,5	22	50	35	25

### Delivered equipped:

per 1 piece clamping nut  $\varnothing 38$  (350020110),  $\varnothing 58$  (350020112) and M10 clamping screw

Order No.	L1	L2	L3	d1	d2	d3
300150131	11,5	5,5		40	25	

### Delivered equipped:

per 1 piece clamping nut  $\varnothing 38$  (350020110),  $\varnothing 70$  (350020113) and M10 clamping screw

Order No.	L1	L2	L3	d1	d2	d3
300150141	11,5	5,5		50	25	

## Accessories Rollomatic grinding wheel adapter $\varnothing 25$ mm // stepped Shaft $\varnothing 25$ , $\varnothing 35$ , $\varnothing 50$ mm

Order No.	Name	for d	
350020110	Clamping nut Rollomatic $\varnothing 38$ x 10 M24 x 1	25	
350020111	Clamping nut Rollomatic $\varnothing 48$ x 10 M34 x 1	35	
350020112	Clamping nut Rollomatic $\varnothing 58$ x 11 M39 x 1	40	
350020113	Clamping nut Rollomatic $\varnothing 70$ x 12 M49 x 1	50	

Order No.	Name	
350016001	Spacer ring $\varnothing 38$ x $\varnothing 25$ x 5	
350016002	Spacer ring $\varnothing 58$ x $\varnothing 40$ x 5	
350016003	Spacer ring $\varnothing 70$ x $\varnothing 50$ x 5	
350016005	Spacer ring $\varnothing 48$ x $\varnothing 35$ x 5	

# Rollomatic HSK50 // stepped Shaft $\varnothing 25$ , $\varnothing 35$ , $\varnothing 50$ mm

For Rollomatic tool grinding machines

## GWA HSK50 // stepped Shaft

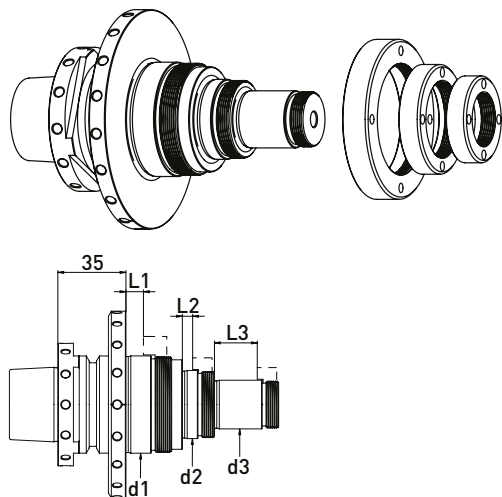

### Delivered equipped:

per 1 piece clamping nut  $\varnothing 38$  (350020110),  $\varnothing 48$  (350020111),  $\varnothing 70$  (350020113) and M10 clamping screw

Order No.	L1	L2	L3	d1	d2	d3
300150921	7,5	5,5	22	50	35	25

## Accessories Rollomatic grinding wheel adapter $\varnothing 25$ mm // stepped Shaft $\varnothing 25$ , $\varnothing 35$ , $\varnothing 50$ mm

Order No.	Name	for d
350020110	Clamping nut Rollomatic $\varnothing 38 \times 10$ M24 x 1	25
350020111	Clamping nut Rollomatic $\varnothing 48 \times 10$ M34 x 1	35
350020112	Clamping nut Rollomatic $\varnothing 58 \times 11$ M39 x 1	40
350020113	Clamping nut Rollomatic $\varnothing 70 \times 12$ M49 x 1	50

Order No.	Name
350016001	Spacer ring $\varnothing 38 \times \varnothing 25 \times 5$
350016002	Spacer ring $\varnothing 58 \times \varnothing 40 \times 5$
350016003	Spacer ring $\varnothing 70 \times \varnothing 50 \times 5$
350016005	Spacer ring $\varnothing 48 \times \varnothing 35 \times 5$

\*related items

# Rollomatic HSK-E50 // Shaft $\varnothing 20$ mm // RS $\varnothing 50$ mm

For Rollomatic tool grinding machines with ring set  $\varnothing 50$  mm

## GWA HSK-E50 // $\varnothing 20$ mm // RS $\varnothing 50$ mm

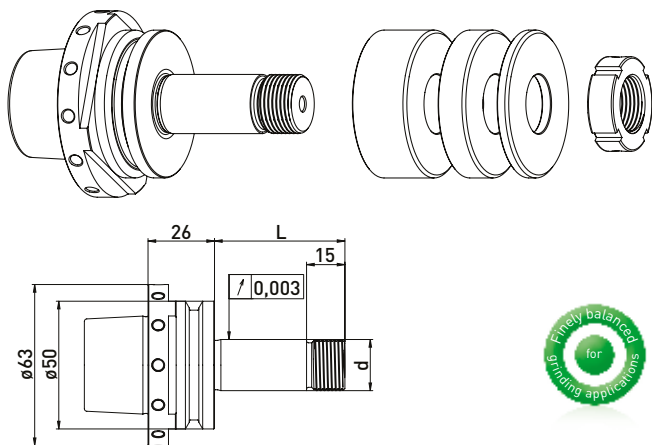

Delivered equipped:  
Ring set  $\varnothing 50$  mm and clamping nut

Order No.	HSK	d	L	Ring set $\varnothing 50$ mm		
				B 20	B 10	B 4
300150612	HSK-E50	20	51	1	1	2
300150632	HSK-E50	20	81	2	2	2

## GWA HSK-E50 // $\varnothing 20$ mm // without RS

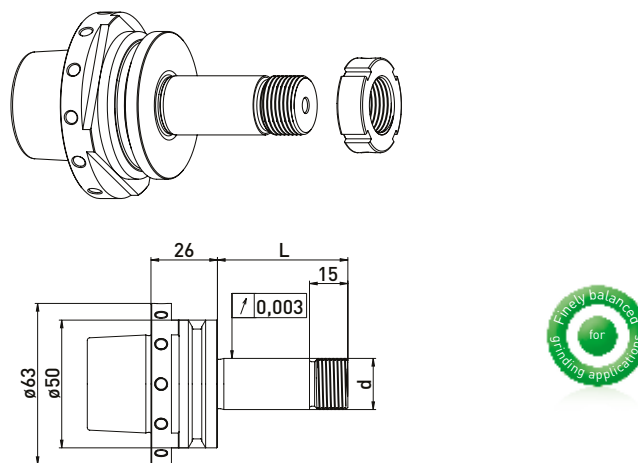

Delivered equipped:  
Clamping nut

Order No.	HSK	d	L
300150611	HSK-E50	20	51
300150631	HSK-E50	20	81

## Accessories Rollomatic grinding wheel adapter GWA HSK-E50 // Shaft $\varnothing 20$ mm // RS $\varnothing 50$ mm

Order No.	Name
350040051	Hook wrench 30 - 32 mm



Order No.	Name
350011520	Spacer ring Rollomatic $\varnothing 50 \times \varnothing 20 \times 20$
350011510	Spacer ring Rollomatic $\varnothing 50 \times \varnothing 20 \times 10$
350011504	Spacer ring Rollomatic $\varnothing 50 \times \varnothing 20 \times 4$
350020121	Clamping nut MRR20 x 1,5 M20 x 1,5 $\varnothing 32 \times 10$
350015003	Support washer $\varnothing 50 \times \varnothing 75 \times \varnothing 20 \times 6$

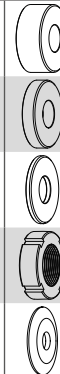

# Rollomatic HSK50E // Shaft $\varnothing 20$ mm // RS $\varnothing 50$ mm

For Rollomatic tool grinding machines with ring set  $\varnothing 50$  mm  
with cross groove

SSA HSK50E //  $\varnothing 20$  mm // RS  $\varnothing 50$  mm

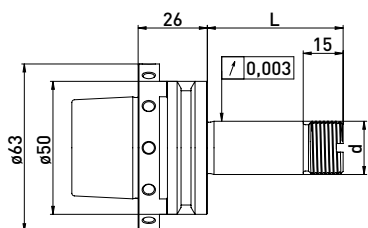
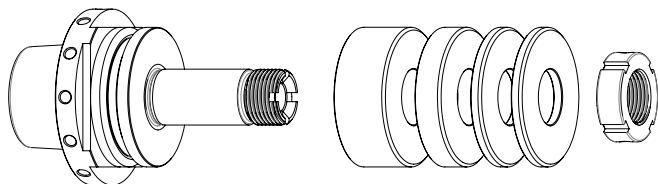

Delivered equipped:  
Ring set  $\varnothing 50$  mm and clamping nut

Ring set  $\varnothing 50$  mm

Order No.	HSK	d	L	Ring set $\varnothing 50$ mm		
				B 20	B 10	B 4
300150652	HSK50E	20	51	1	1	2
300150662	HSK50E	20	81	2	2	2

SSA HSK50E //  $\varnothing 20$  mm // ohne RS

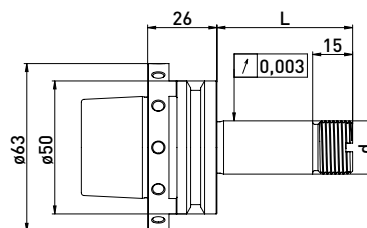
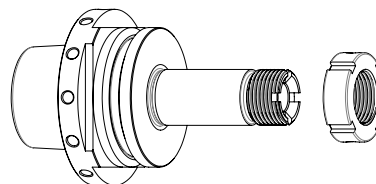







Delivered equipped:  
Clamping nut

Order No.	HSK	d	L
300150651	HSK50E	20	51
300150661	HSK50E	20	81

## Accessories Rollomatic grinding wheel adapter GWA HSK-E50 // Shaft $\varnothing 20$ mm // RS $\varnothing 50$ mm

Order No.	Name
350040051	Hook wrench 30 - 32 mm 

Order No.	Name	
350011520	Spacer ring Rollomatic $\varnothing 50 \times \varnothing 20 \times 20$	
350011510	Spacer ring Rollomatic $\varnothing 50 \times \varnothing 20 \times 10$	
350011504	Spacer ring Rollomatic $\varnothing 50 \times \varnothing 20 \times 4$	
350020121	Clamping nut MRR20 x 1,5 M20 x 1,5 $\varnothing 32 \times 10$ 	
350015003	Support washer $\varnothing 50 \times \varnothing 75 \times \varnothing 20 \times 6$ 	

\*related items



# Rollomatic HSK-E50 // Shaft $\varnothing 31,75$ mm (1¼) // RS $\varnothing 60$ mm

For Rollomatic tool grinding machines with ring set  $\varnothing 60$  mm

## GWA HSK-E50 // $\varnothing 31,75$ mm (1¼) // RS $\varnothing 60$ mm

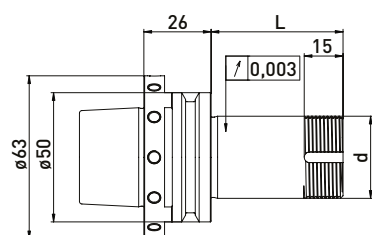
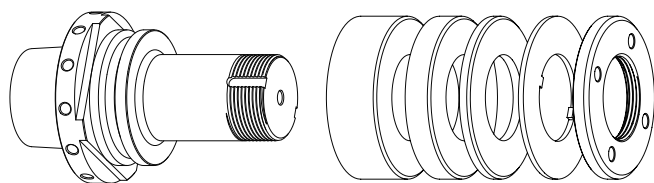

**Delivered equipped:**  
Ring set  $\varnothing 60$  mm and clamping nut

## GWA HSK-E50 // $\varnothing 31,75$ mm (1¼) // without RS

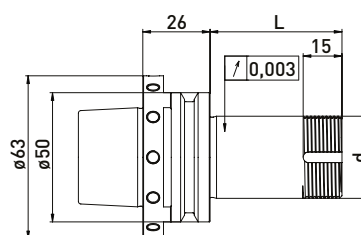
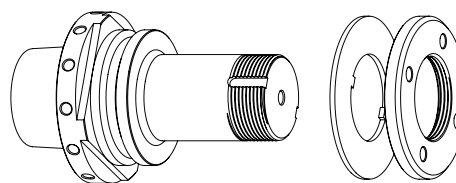

**Delivered equipped:**  
Clamping nut

### Ring set $\varnothing 60$ mm

Order No.	HSK	d	L	B 20	B 10	B 4
300150712	HSK-50E	31,75	51	-	1	3
300150732	HSK-50E	31,75	81	1	1	3

Order No.	HSK	d	L
300150711	HSK-50E	31,75	51
300150731	HSK-50E	31,75	81

## Accessories Rollomatic grinding wheel adapter HSK-E50 // Shaft $\varnothing 31,75$ mm (1¼) // Ring set $\varnothing 60$ mm

Order No.	Name	
350040030	*Clamping nut wrench PC39 for clamping nut with blancing option	
350040020	Clamping nut wrench PC45 for $\varnothing 32$	
350020023	*Balancing weight pair for clamping nut $\varnothing 60$ // 200gmm	

Order No.	Name	
350011420	Spacer ring $\varnothing 60 \times \varnothing 31,75 \times 20$	
350011410	Spacer ring $\varnothing 60 \times \varnothing 31,75 \times 10$	
350011404	Spacer ring $\varnothing 60 \times \varnothing 31,75 \times 4$	
350030060	Lock washer $\varnothing 60 \times \varnothing 32 \times 1,8$	
350020066	Clamping nut $\varnothing 60 \times 6 \times M32 \times 1,5$ PC45	
350020022	*Clamping nut with balancing option $\varnothing 60 \times 9$ M32 x 1,5 PC39	